

FOR AMIGA® 4000,

3000 AND 2000 USERS

# **ioEXTENDER™**

**USER'S**

**GUIDE**



TXX0003064

Scanned  
by  
405h





# *IO* **Extender**

A horizontal double-headed arrow pointing left and right, positioned below the title.

**High Speed  
Serial and Parallel  
Expansion  
for the  
A4000, A3000  
and A2000**

Tanji Ananda-Manjals-Website



This manual, the IOExtender board, distribution disk and all related materials are copyright 1992, 1993, Great Valley Products, Inc. (GVP). A2000 G-Force '040, Series II, FaaastROM, DSS are copyright 1991, 1992, 1993, GVP. All rights reserved.

This product requires version 1.3, or later, of Kickstart. Installation of this product requires some degree of mechanical ability and precautions against electrostatic discharge. The user assumes all risks when this installation is performed by anyone other than a certified GVP dealer.

Workbench, Kickstart, Amiga, A4000, A3000, A2000, AmigaDOS and Enhancer are all registered trademarks of Commodore International, Ltd. All other product trade names and designations are used for illustrative purposes only and are in no way endorsements of those products or infringements on the copyrighted properties of their manufacturers.

Taken from AmigaMagazine.de - Weisste



# Table of Contents

<b>1. Introduction</b>	
Product Overview .....	1.1
Basic Hardware .....	1.3
System Architecture .....	1.5
IOExtender Uses .....	1.6
Software Compatibility .....	1.7
<b>2. Getting Started</b>	
Configuration .....	2.1
Connecting External Port Option .....	2.4
Hardware Installation .....	2.6
Power-Up Test .....	2.8
Software Installation .....	2.9
<b>3. Software Reference</b>	
GVPIOControl .....	3.2
GVPSerial Preferences .....	3.7
<b>4. Application Examples</b>	
Modem and Serial Printer .....	4.1
Multimedia Presentation System .....	4.4
Multi-line Bulletin Board System .....	4.6
DSS with a Parallel Printer .....	4.6
<b>5. Troubleshooting</b>	
<b>Appendix A. Customer Service</b>	
<b>Index</b>	



## FCC Class "B" Radio Frequency Emissions Statement

This equipment has been tested and found to comply with the limits for a Class B digital device, pursuant to part 15 of the FCC Rules. These limits are designed to provide reasonable protection against harmful interference in a residential installation.

This equipment generates, uses and can radiate radio frequency energy and, if not installed and used in accordance with the instructions, may cause harmful interference to radio communications. However, there is no guarantee that interference will not occur in a particular installation. If this equipment does cause harmful interference to radio or television reception, which can be determined by turning the equipment off and on, the user is encouraged to try to correct the interference by one or more of the following measures:

- \* Reorient or relocate the receiving antenna.
- \* Increase the separation between the equipment and receiver.
- \* Connect the equipment into an outlet on a circuit different from that to which the receiver is connected.

**CAUTION: Only equipment with shield-grounded cables (computer input-output devices, terminals, printers, etc.), certified to comply with Class B limits, can be attached to this device. Operation with non-certified equipment may result in communications interference.**

Your house AC wall receptacle must be a three-pronged type (*AC ground*). If not, contact an electrician to install the proper receptacle. If a multi-connector box is used to connect the computer and peripherals to AC, the ground must be common to all units.

If necessary, contact your dealer or an experienced radio-TV technician for additional suggestions. You may find the following FCC booklet helpful: *"How to Identify and resolve radio-TV Interference problems."* The booklet is available from the U.S. Government Printing Office, Washington, D.C. 20402, Stock no. 004-000-00345-5.



## 1. Introduction

We, at GVP, appreciate your purchase of the IOExtender. Over the years, many Amiga users have expressed their frustration at the limited availability of outside-world communications ports that seemed to hamper their creativity. At GVP, we listen to those concerns. We're certain you'll appreciate the added flexibility that the IOExtender system will bring to you.

This user's guide is designed to make it as quick and easy as possible for you to install, set-up, and use up to five IOExtender boards. And, if you already own, or plan to purchase, a GVP A2000 G-Force '040 accelerator, you'll see how that product and the IOExtender complement each other.

Whatever your serial, parallel or other connection requirements, the GVP IOExtender gives your Amiga A4000, A3000 or A2000 the flexibility it needs in today's competitive marketplace.

### PRODUCT OVERVIEW

Each GVP IOExtender board features a high speed, multi-function serial port and 1 parallel port for all your current and future needs. With the IOExtender, your connection possibilities are virtually endless:

- Mix and match a full range of peripherals all at the same time (*e.g., modem; printer, etc.*)
- Leave your built-in Amiga ports free for other uses

- The RS-232 compliant serial port has its own 16 byte receive and transmit buffers, eliminating the data loss associated with the Amiga's own serial port
- Serial port communication speeds in all popular baud rates
- Industry standard PC AT-style, DB-9 serial connector
- Bi-directional parallel port (*DB-25*) can be configured as electrically identical to an Amiga's or PC compatible's
  - The Amiga parallel port uses pin 14 to send power to peripherals
  - PC compatibles use this pin for data
- When properly configured, the parallel port supports most existing video digitizers, scanners, sound samplers and printers
- Software switchable option connector for future RS-422 serial expansion
- The IOExtender Board's easy-to-use software affords complete control at all times over which connections are in use

## IOExtender Basic Hardware

Each IOExtender has two connection ports mounted on the back end of the board. These connectors—the parallel port and the serial port—extend out the Amiga's rear panel.

## Optional Hardware

A second serial port, mounted on an additional rear slot cover bracket and attached to the IOExtender board via ribbon cable, can be added as a cost-extra option.

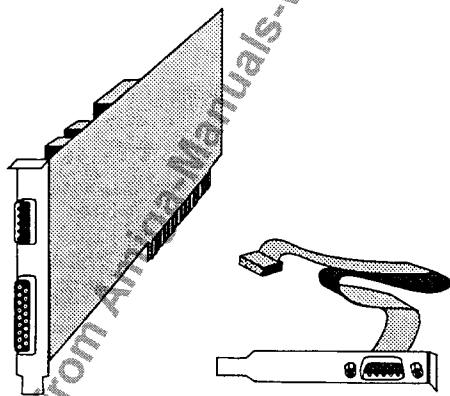
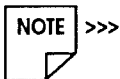

Figure 1.1 – IOExtender with optional second serial port bracket.

Complete details on how to attach and install these options will be provided in *Chapter 2 – Getting Started*.





The IOExtender, equipped with the second serial port option, has two serial channels, each of which may be used for RS-232 communication.

An alternative option connector, supporting industry standard RS-422 communication protocols, is also available for purchase separately.

The IOExtender's ports are assigned as follows:

- **Parallel Unit 0** – a 25-pin connector on IOExtender board
- **Serial Unit 0** – a 9-pin male connector on IOExtender board
- **Serial Unit 1** – a 9-pin male connector on extension bracket (*available as an option*)

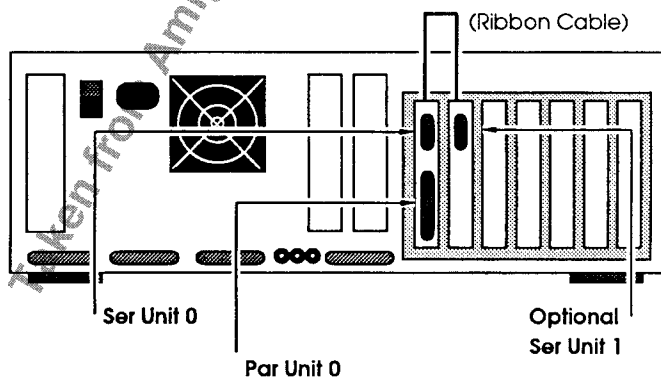
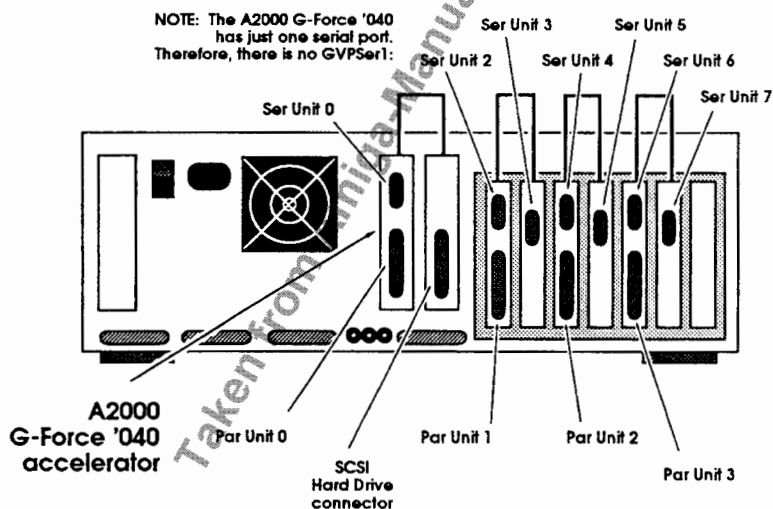

Figure 1.2 – IOExtender port assignments.

## IOExtender System Architecture

You may purchase and use as many IOExtender boards as you have free Zorro expansion slots. In all cases, your access to and control over the numerous available serial and parallel communications ports will be controllable through the same consistent software interface.

Each port is assigned a unique ID number so that it can be individually addressed by your applications software. These numbers are allocated by counting "down" the expansion bus: Parallel 0, Parallel 1, Parallel 2, etc. *Figure 1.3* illustrates how this is done.



*Figure 1.3 – Port assignments of G-Force accelerator and multiple IOExtender boards.*

GVP's A2000 G-Force '040 accelerator offers its own additional serial and parallel ports consistent with the IOExtender system architecture and port control software. In this case, the parallel port on the G-Force '040 board is assigned as Parallel Unit 0 and its serial port is Serial Unit 0.

The A2000 G-Force '040 accelerator does not support a second serial port option, so the designator Serial Unit 1 is reserved and will not be used. This configuration is illustrated in *Figure 1.3*. You may also choose to install several IOExtender boards side-by-side and carry all of their external port brackets over to the PC bus slot covers.

### IOExtender Uses

There are many different kinds of applications for IOExtender. The following table lists some of the possibilities:

**TABLE 1.1**  
**POTENTIAL IOEXTENDER USES**

<b>Parallel:</b>	<b>Serial:</b>	
Printers	Modems	Networks
Scanners	Edit controllers	Laserdisc control
Floptical drives	Serial mice	Digitizing tablet
Networks	Plotters	Automated
Video digitizers	Vinyl cutters	systems
Audio digitizers	Data acquisition	control
Data acquisition	Consumer	Laboratory
Industrial process control	electronics	equipment
	Machine tools	

## Software Compatibility

The Amiga operating system assumes that there is just one serial port and one parallel port. Direct access to these two ports on a hardware level is normally reserved to the multitasking kernel of the Amiga's operating system. Applications software is supposed to use high-level system calls to receive or transmit through the Amiga parallel and serial ports; either through a logical device name (*SER:*, *PAR:*, *PRT:*), or a device driver (*serial.device*, *parallel.device*). Applications that directly access the port hardware will not be compatible with IOExtender.

The IOExtender's added ports will be most immediately useful to programs—such as BBS systems, telecommunications software, and print spoolers—that can be configured to access them. There are three different ways that your software can make use of the IOExtender's ports. The preferred method involves reconfiguring the program itself. Many telecommunications programs, for instance, allow you to specify the name and unit number of the serial port you wish to use.

The next most desirable method involves the use of our own logical device designations *GVPPar0:* and *GVPser0:*. These are managed by a “handler” resource in the system *L:* directory. Some programs—print spoolers, for instance—allow you to specify such a logical designator as the output device.

Finally, for software that cannot be reassigned in any other way, GVP provides a means of intercepting, on a system level, all calls to the Amiga's own parallel or serial devices and redirecting them to the corresponding GVP ports.

*Chapter 3 – Software Reference* will describe the utility programs we provide to make this possible.



(This page left blank)

*Taken from Amiga-Manual-Website*

## 2. Getting Started

### Configuration

The IOExtender board has several physical settings that allow you to configure certain hardware options. All other control can be accomplished through software. You will likely only change one of these settings, although all of them are detailed below for reference purposes.



**CAUTION:** IOExtender boards are sensitive to static discharge or physical shock. Always be sure to ground yourself by touching a metal surface prior to handling the board or its components. Do not drop or physically jar the board or its components. Failure to observe these precautions may result in irreparable damage to the IOExtender board.

### Jumpers

The IOExtender board is configured through the use of *jumper pins* and *shorting blocks*. At various points on the board are a number of upright metal pins. These are connection points for various open circuits. Installing a shorting block onto a pair of pins completes the circuit.



Figure 2.1 – Jumper block and pins.

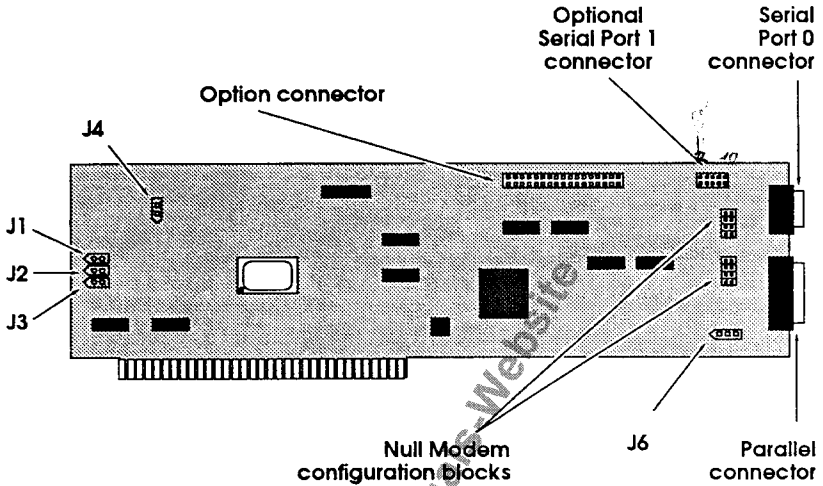

Figure 2.2 - IOExtender board jumper locations.

**Table 2.1**  
**JUMPER DEFAULT SETTINGS**

<b>Jumper</b>	<b>Open</b>	<b>Closed</b>	<b>Default</b>
J1	RESERVED	RESERVED	Open
J2	RESERVED	RESERVED	Open
J3	RESERVED	RESERVED	Open
J4	RESERVED	RESERVED	Open
<b>Jumper</b>	<b>Pins 1 &amp; 2</b>	<b>Pins 2 &amp; 3</b>	<b>Default</b>
J6	Amiga Parallel	PC compatible Parallel	Pins 1 & 2

NOTE: The IOExtender board does not contain a jumper labeled J5.

NOTE &gt;&gt;&gt;

Three-pin jumpers have polarity which is indicated either by a pointed end on the jumper pin mount, itself, or in white ink on the surface of the circuit board. Pin one is the pin closest to the pointed end.

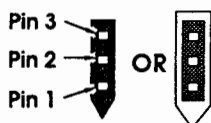

Figure 2.3 – Jumper pin numbering.

### Parallel Port

Amiga standard parallel ports differ slightly from those on most PCs. This can lead to problems when cabling various types of printers. The Amiga port supplies voltage on one of its pins (*allowing such devices as sound samplers and video digitizers to derive their power from the Amiga's supply*). If you mistakenly connect the wrong type of printer cable, this voltage can damage printers or other parallel devices that do not expect to find voltage on this pin.

The IOExtender board's parallel port can be set to behave as either an Amiga parallel port (*with 5 volts supplied on pin 14*), or as an IBM standard parallel port (*with no power supplied*). Selection is accomplished by setting jumper J6 as shown:

NOTE &gt;&gt;&gt;

**WARNING:** When configured as an Amiga standard parallel port, pin 14 on the DB-25 connector will carry 5 Volts. Be sure to use proper cabling in order to avoid damaging your parallel peripherals.

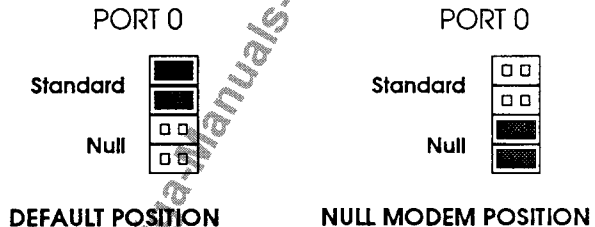

Figure 2.4 – Jumper setting for IOExtender parallel port.



### Null Modem Option

While most users will operate the IOExtender's serial ports as standard RS-232 devices, we provide the means to change one or both ports to a Null Modem configuration. This setting simply switches the Transmit Data (*TXD*) and Receive Data (*RXD*) lines. It does not alter the hardware handshaking lines. If you wish to make this change, move the pair of jumper blocks from one position to the other as shown in *Figure 2.5*. This information is also indicated directly on the IOExtender circuit board.



*Figure 2.5 – Null Modem configuration option.*

## Connecting External Port Option



>>> **The following discussion applies only to those users who purchase the second RS-232 Serial port option.**

First, you must decide which rear panel expansion slot you wish to use for the IOExtender's external port connector bracket. Normally, you will use one of the unoccupied Zorro or PC expansion slots.

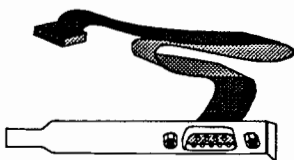
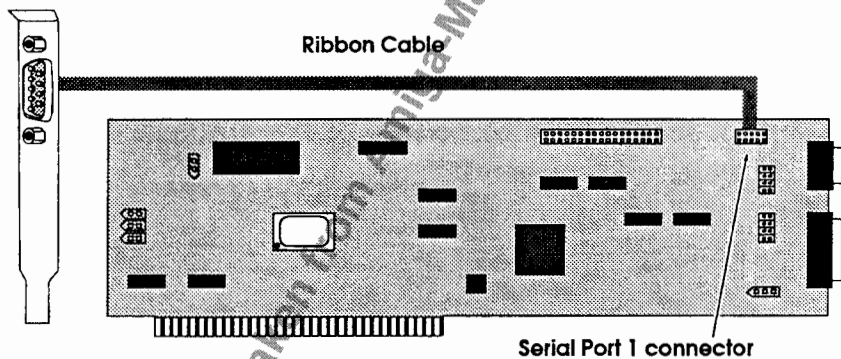

**Figure 2.6 – Ribbon cable and bracket assembly (with alternate slot cover plate).**

Locate the 10-pin header at the top edge of the IOExtender board (see Figure 2.7) and attach the ribbon cable as illustrated. Both parts of the ribbon cable connection are *keyed* and can only be attached one way.

2

Serial Port 1



**Figure 2.7 – Connecting external port bracket.**

Once you have attached the external port connector bracket, correctly set jumper **J6** and determined that all others are properly configured, you may proceed to install the board into your Amiga.

## Hardware Installation

2

When you have properly configured your IOExtender board, it is ready to install. Follow the procedure described in your Amiga User's manual for removing the computer's outer case. If there is a procedure for adding Zorro bus expansion cards follow that; otherwise perform the following procedure:

1. Select an empty Zorro expansion slot to receive the IOExtender board.

You may use any available Zorro slot for the IOExtender, but you will probably want to reserve the video slot for an expansion product that requires it.

2. Use a cross-point screwdriver to remove the expansion slot cover from the rear panel of the Amiga. If you are installing a second serial port option, remove a second slot cover (or CPU slot cover), as well.

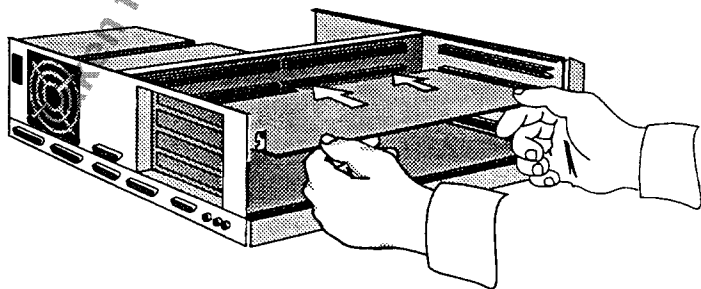

Figure 2.8 - Installing IOExtender  
in an A3000/A4000 (A3000 depicted).

3. Align the IOExtender board with the plastic slot guide at the front of the expansion slot. Take care that the board's external connectors extend through the correct expansion slot opening in the Amiga's rear panel (see either Figure 2.8 or 2.9).
4. Take care to align the card edge-connector with the Zorro slot and press firmly until the board is fully seated.
5. Secure the IOExtender board in place with the screw you removed earlier.
6. If you are installing the optional second serial port, locate its bracket into the remaining empty slot cover position and secure it with the screw(s) you removed from that location.

2

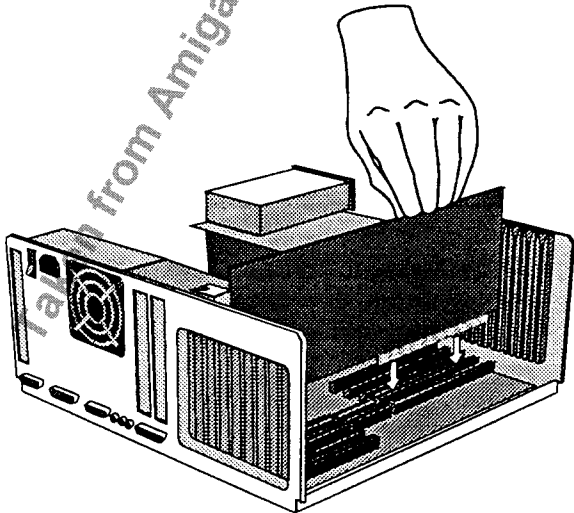

Figure 2.9 – Installing IOExtender  
in an A2000.

7. Check over your work to make sure that all connection points are solid and that no wires or ribbon cables connected to other components were disturbed. Then, replace the Amiga's cover.
8. Connect your external devices (*printers, modems, etc.*) to the IOExtender board's parallel or serial connectors.

## Power-Up Test

---

Once you have installed the GVP IOExtender board, it should be ready for use. Before you can control it, however, you will need to install the IOExtender software. This will be described in the following pages. Before proceeding to that stage, however, we urge you to power-up your computer and verify that it boots normally.

**WARNING:** If the computer does not boot right away, power down immediately and recheck all your work for shorted or incomplete connections. Operating your computer with shorted connections can do irreparable harm to the IOExtender board, or the Amiga, itself.

If the computer boots normally, proceed to the next section of this chapter – *Software Installation*.

## Software Installation

---

When you have installed the IOExtender board and restored your computer to running condition, you are ready to install the IOExtender software. This step is fully automated and can be accomplished with a minimum of effort.

2

### Procedure

- 1) Start up your computer in your accustomed fashion. You must boot from your normal startup System disk for the installation to be successful.
- 2) Insert the *GVP-Install* disk into your Amiga's floppy drive.
- 3) Double-click on the *GVP-Install* disk icon. In the window that opens, you will see an icon for the software installation program: *Install-IOExtender*.
- 4) Double-click the *Install-IOExtender* icon to start the installation procedure. The installation script uses Commodore's standard Installer program. A series of windows will open and prompt you for various pieces of information.

Depending on your experience as an Amiga user, you may choose how much control you will have over the installation process:

- Novice
- Intermediate
- Expert



You can also choose to run the installation program in a “pretend” mode if you select the **Expert** installation option. This will let you verify every stage of the installation process before any changes are committed to your hard drive.

When you have selected to install the software for real and the Installation procedure has run its course, you should be ready to use your new IOExtender.

*Taken from Amiga-Manuals-Website*

## 3. Software Reference

By the time you have reached this chapter, you should already have the IOExtender board installed in your Amiga. If you haven't, be sure to read *Chapter 2 – Getting Started* thoroughly before proceeding.

NOTE >>>

If you did not use the GVP supplied Installation program, make sure that the file `SetDevice` is copied into your current command path and that it is run before proceeding. Install will ordinarily add the line:

```
Run >NIL: SetDevice
```

to your startup sequence to ensure that it is active when GVPIOControl tries to use it.

### Addressing IOExtender Ports

We provide three different ways for your software to make use of the IOExtender board's ports. The most flexible way requires that your software—a telecommunications program, for instance—be individually configured to address the GVP port directly. In the popular shareware terminal program, *JRComm*, for instance, you can specify the name of the serial port you wish to use. In this case, you would type `gvpsr.device` in place of the default `serial.device`.

The next method involves the use of logical device designations `GVPPar0:` and `GVPSer0:`. These are managed by a “handler” resource in the system `L:` directory.



Some programs allow you to specify such a logical designator as the output device. AREXX programmers will find this the preferred method for customized multimedia systems.

Finally, for software that cannot be reassigned in any other way, we provide a means of intercepting, on a system level, all calls to the Amiga's parallel or serial devices and redirecting them to the corresponding GVP ports. The tool for achieving this is called *GVPIOControl*.

## GVPIOControl



**GVPIOControl**

Unless specifically written for an expandable system, not all software will be able to access the IOExtender board's ports. *GVPIOControl* allows you to intercept ordinary system calls to the Amiga's serial or parallel ports and have them redirected to the ports on the IOExtender. In this way, you can make these ports the defaults for most current software.

*GVPIOControl* sets default conditions for another program: *SetDevice*, which has been copied to your system disk by the installation program. *SetDevice* will be run each time you boot your system and will immediately begin monitoring the serial and parallel ports for activity. If *GVPIOControl* tells it to, it will divert data to the IOExtender ports instead of the Amiga's ports.

Click twice to open the Prefs drawer and click twice on the *GVPIOControl* icon to launch this program.

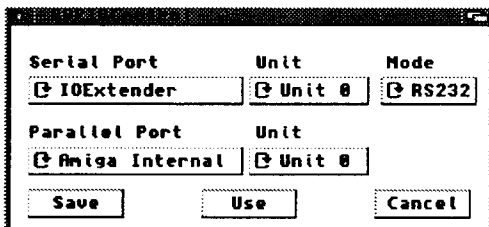

Figure 3.1 - GVPIOControl window.

## Default Serial Port

Clicking on the **Serial Device** button will toggle between **Amiga** and **IOExtender** settings. When you select **Amiga** as the default, the system will operate normally, sending all system calls to the Amiga's built-in serial port connector.

### Default Serial Port



When you select **IOExtender**, all system calls to the Amiga's serial port will be intercepted by **SetDevice** and rerouted to the designated serial port on the IOExtender board. This setting requires that you make two additional selections: **Unit Number** and **Port Connector (RS232/AUX)**.

## Unit Number Selection

Clicking on the **Unit Number** button will cycle upward through all available Unit numbers. Holding down the Shift key while clicking will cycle backward through the available Unit numbers. Normally, the **Unit Number** selector will default to 0. If you have installed the IOExtender's optional second port (*port number 1*), and wish to make *it* the default, advance the **Unit Number** selector to 1.

If your system includes a GVP A2000 G-Force '040 accelerator, its serial port will always be assigned as Unit 0. Unit 1 is not used, since the G-Force board can have only one serial port. In this case, the first port on your IOExtender board will become Unit 2 and its second port (*if installed*) will be Unit 3. If there are other IOExtender boards present, you can select any serial port from any one of these boards, simply by cycling through the Unit ID numbers. Refer to the discussion in *Chapter 1 – Introduction* for port numbering order.

### Serial Port Connector

The third button, **Serial Port Connector**, tells the IOExtender software which physical port connector to send data through. You will recall from the Configuration section of Chapter 2 that there are two multi-pin connectors along the top edge of the IOExtender board. If you installed the external port bracket, you connected ribbon cables to the Serial 1 connector. The 34-pin Option or Auxiliary connector is currently reserved for future use.

When set to **RS-232**, The IOExtender software will address the currently selected port through the 9-pin male DB-style connector mounted at the back of the IOExtender board or to the 9-pin male DB connector on the external bracket (*depending which port is selected*). When **AUX** is selected, the signals will be sent to the 34-pin Option header. At this time, the **AUX** setting should not be used.

NOTE

>>>

**The AUX setting is provided in support of future products. At the present time, do not select AUX.**

## Default Parallel Port

Clicking on the **Parallel Device** button will toggle between **Amiga** and **IOExtender** settings. When you select **Amiga** as the default, the system will operate normally, sending all system calls to the Amiga's built-in parallel port connector.

### Default Parallel Port

<input type="radio"/> IOExtender	<input checked="" type="radio"/> Unit 0
----------------------------------	---

When you select **IOExtender**, all system calls to the Amiga's parallel port will be intercepted by **SetDevice** and rerouted to the parallel port on the indicated **IOExtender** board. This setting requires that you make one additional selection: **Unit Number**.

### Unit Number Selection

Clicking on the **Unit Number** button will cycle upward through all available **Unit** numbers. Holding down the **Shift** key while clicking will cycle backward through the available **Unit** numbers. Each **IOExtender** board has only one parallel port, so the **Unit Number** selector will default to 0.

If your system includes a GVP A2000 G-Force '040 accelerator, its parallel port will always be assigned as **Unit 0**. In this case, the parallel port on your **IOExtender** board will become **Unit 1**. **Unit 2** would address the parallel port on the next **IOExtender** board, and any other parallel ports on additional boards are referenced in sequence as **Unit 3**, **Unit 4**, etc. Refer to the discussion in *Chapter 1 – Introduction* for port numbering order.

### Exiting GVPIOControl

When you have set the GVPIOControl parameters to your liking, you can click the **Save** button to record them as the default system configuration. These settings will then become operative each time you reboot your system. If you do not want the settings to be permanently recorded, click the **Use** button. The configuration will remain operative only until your next system reboot. If you decide to exit the program without making any changes, click the **Cancel** button and any parameters that were altered will be restored to their original condition.

### Effective Use

As mentioned, GVPIOControl is the least flexible method for using the ports on your IOExtender board. Since it wedges itself into the Amiga's operating system and intercepts all calls on a system level, it effectively substitutes the GVP ports for your Amiga's ports. It does not necessarily permit one program to use the GVP ports while other programs are free to use other ports.

The only way to actually use multiple serial and multiple parallel ports simultaneously is through individual applications programs that permit their input and output ports to be specified either as logical devices (`GVPPar0:`, `GVPSER1:`, etc.) or as physical devices (`gvpar.device`, `gvpsr.device`, etc.).

## GVPSerial Preferences



The serial ports on the IOExtender board (and any other serial ports on a A2000 G-Force '040 accelerator or additional GVP IOExtender expansion boards) can be controlled through a preferences utility that functions much the same as the standard Workbench preferences utilities. This program is automatically installed in your Prefs drawer by the *Install-IOExtender* program.

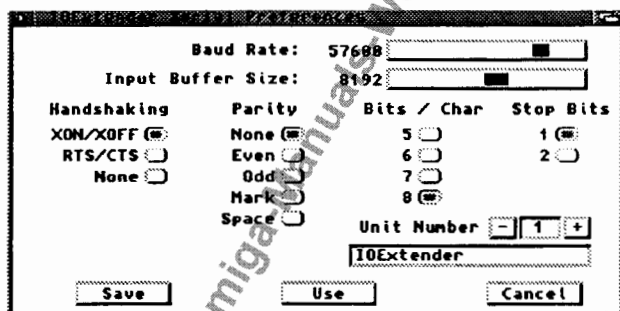

Figure 3.2 – GVPSerial preferences panel.

### Baud Rate

The serial port on the IOExtender board is capable of a much wider range of transmission speeds than the standard Amiga serial port. Drag the slider to set the serial port's transfer rate. As you do so, the numbers displayed to the left will increment (or decrement), to show the value obtained.

Baud Rate: 57600

3

All transfer rate settings are expressed in terms of bits per second (*bps*) except **MIDI**, **CUSTOM** and **MAXIMUM**. The **MIDI** setting is typically 31,250 bps. The **MAXIMUM** setting will simply drive the serial port as fast as it can. In order to set your own custom transmission rate, adjust the **Baud Rate** slider until **CUSTOM** is displayed. Then, locate the **Miscellaneous Menu** (by holding down the **Right Mouse Button** and moving the mouse pointer up to the top of the screen).

When you select the **Miscellaneous/Set Custom Baud Rate** menu item, a requester window will open. This requester contains a text-entry field into which you can type any specific baud rate desired. Note that you may specify only transfer rates of which the IOExtender is capable. If the GVPSerial utility is unable to deliver exactly the rate requested, it will report the actual rate achieved and the percent of variance from the specified value.

### Input Buffer Size

Unlike the Amiga's standard serial port, the IOExtender's serial ports have hardware buffers of 16 bytes each for receiving and transmitting. Each port also has a variable-size software buffer where incoming data can be cached while your application is busy doing other things.

**Input Buffer Size:** 8192 

You can set the **Input Buffer Size** by adjusting the slider until the desired value is displayed. Acceptable values range from 512 to 65,536 bytes. A 2 Megabyte Amiga system can easily support a 16k serial buffer.

## Handshaking

Although serial devices are two-way communi- cators, information can only be passed through sequential exchanges.

One device *talks* while the other one *listens* and vice versa. Handshaking protocols are the means by which two serial devices determine which talks when.

### Handshaking

XON/XOFF

RTS/CTS

None

- **XON/XOFF** is a software-based protocol. When a **XON** character is received, the sending unit knows to begin transmitting. When a **XOFF** character is received, the sender stops transmitting and waits for the next **XON** signal.
- **RTS/CTS** is a hardware-level protocol. When compatible devices are connected with the proper cables, transfers will be managed entirely through the circuitry built into the equipment. The sending device transmits a *Request To Send (RTS)* signal and waits for a *Clear To Send (CTS)* reply.
- **None**. Some unusual equipment may not require handshaking protocols at all. When **None** is selected, data will be sent as quickly as the hardware permits. If something on the other end interferes with the orderly processing of data as it is received, some information will be lost.



### Parity

Parity is a method of checking for errors while data is being transmitted. A Parity bit is used to adjust each transmitted character to meet these criteria:

- Parity**
- None
  - Even
  - Odd
  - Mark
  - Space

- **NONE** means that no parity bit is used.
- **EVEN** means that the total number of 1 bits in each transmitted character is even. If the source data contains an odd number of 1 bits, then the Parity bit will be set to 1. If the source data has an even number of 1 bits, the Parity bit will be 0.
- **ODD** means that the total number of 1 bits in each transmitted character is odd. If the source data contains an even number of 1 bits, then the Parity bit will be set to 1. If the source data has an odd number of 1 bits, the Parity bit will be 0.
- **MARK** means that the parity bit will always be set to 1.
- **SPACE** means that the parity bit will always be set to 0.

### Bits/Character

**Bits/Char** (*Bits per Character*) tells your device how many data bits each character contains. The most common number of bits/character is 8. Many devices still use 7, and your IOExtender will even support older hardware that relies on 5 or 6 bits/character.

- Bits / Char**
- 5
  - 6
  - 7
  - 8

## Stop Bits

**Stop Bits** are used to tell a device to stop sending information down the data path. Some devices require 1 Stop Bit; others expect 2.

### Stop Bits

- 1
- 2



If you configure your serial device to send 5 data bits per character, the Stop Bit choices automatically change from 1 or 2 to 1 or 1.5.

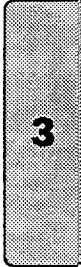

## Unit Number

Each IOExtender can have two serial ports, normally numbered Unit 0 and Unit 1.

Unit Number

IOExtender #2 Port #0

If you have a A2000 G-Force 1040 accelerator, then its serial port becomes Unit 0 and there will be no Unit 1. The IOExtender's serial ports become Units 2 and 3 and, on any additional IOExtender boards installed in your system, each serial port will be assigned an incrementally higher Unit number. The **Unit Number** selector in the GVPSerial utility provides a method for making a unique setup configuration for each separate serial port.

As you cycle through the possible Unit Numbers, the status line beneath the selector will display the identity and location of the selected port.

### GVPSerial Menus

The GVPSerial preferences utility has three menus, in addition to its onscreen buttons and selectors. These menus make it possible to create and save many different configuration presets that can be loaded and used as needed. The complete menus are detailed below:

#### Project Menu

- **Open** loads a predefined settings file and configures the selected serial port accordingly.
- **Save As...** When you click the **Save** button in the GVPSerial preferences utility, the settings become a part of the utility's default configuration. The **Save As...** menu item allows these settings to be saved as a non-default file. This can be reloaded at any time using the **Open** menu.
- **Quit** provides a menu-based method for exiting the GVPSerial preferences utility.



#### Edit

Each GVPSerial preferences project icon contains two sets of

configuration data in the form of Tooltypes: A set of factory defaults and the last saved User Settings. At any time during a GVPSerial preferences configuration session, you can restore either the factory defaults or the last saved settings.

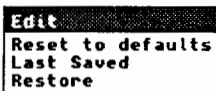

- **Reset to defaults** examines the GVPSerial preferences icon and restores the factory default settings encoded there.



- **Last Saved** examines the GVPSerial preferences icon and restores the User Settings encoded there.
- **Restore** resets the currently selected Unit to the settings in effect prior to the most recent changes.

## Miscellaneous

- **Set Custom Baud Rate.**

When you set the **Baud Rate** slider to its **CUSTOM** setting, you must select this menu item and type your custom transfer rate value into the text-entry field provided.

Miscellaneous

Set Custom Baud Rate

## Exiting GVPSerial Preferences

When you have set the GVPSerial preferences parameters to your liking, you can click the **Save** button to record them into the Tooltypes for the GVPSerial preferences utility icon. These settings will then become operative each time you reboot your system. If you do not want the settings to be permanently recorded, click the **Use** button. The configuration will remain operative only until your next system reboot. If you decide to exit the program without making any changes, click the **Cancel** button and any parameters that were altered will be restored to their original condition.



(This page left blank)

*Taken from Amiga-Manuals-Website*

## 4. Application Examples

The next few sections will present some likely examples of how to connect and use various peripherals and applications software. It is important to remember that there may be many different ways of configuring your own system to your liking. We do not suggest that our methods are any more correct than yours.

### Modem and Serial Printer

Our first example involves connecting both a modem and a serial printer—such as the Apple ImageWriter II—to the IOExtender equipped Amiga. This is a simple arrangement if your telecommunications software allows for user-specified I/O ports. In this case, we will use the first IOExtender serial port for the modem and the second port option for the serial printer.

**NOTE**

**This example assumes you have installed the second serial port option, available separately.**

**Connections:**

- Connect your modem to the first (*onboard*) IOExtender serial port.
- Connect the serial printer to the second IOExtender serial port.

Since most common productivity applications and print utilities do not permit retargeting of the printer port, we will use the GVPIOControl program to accomplish this.

**Preferences Settings:**

- Select the Workbench *Printer Preferences* utility and set it to address the printer from the serial port.

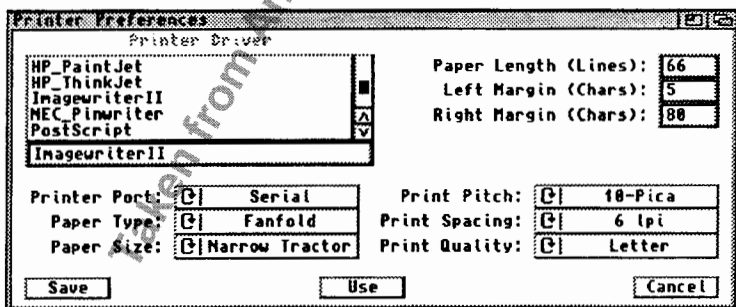

Figure 4.1 – Printer preferences settings for ImageWriter II.

- Open the GVPIOControl preferences utility and set it as follows:

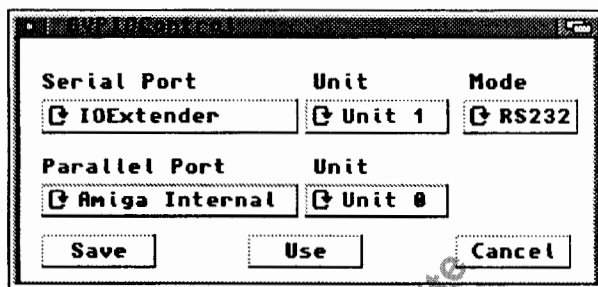

Figure 4.2 – Configuring GVPIOControl to intercept `serial.device` calls.

- Set the **Serial Port** button to IOExtender.
- Set the **Unit** button to Unit 1.
- Make sure the **Mode** button is set to RS-232.

When you **Save** or **Use** these settings, your serial printer will be available to all Amiga programs that output to the `printer.device`.

### Comm Program Settings:

(using JRComm as an example)

- Start JRComm.
- Locate and select the **Options/General** menu item (*Right Amiga 8 is the keyboard shortcut*).
- Make the following settings:
  - Enter `gvpser.device` into the text entry field labeled **Serial Device**.
  - Enter 0 in the **Device Unit** text entry field.



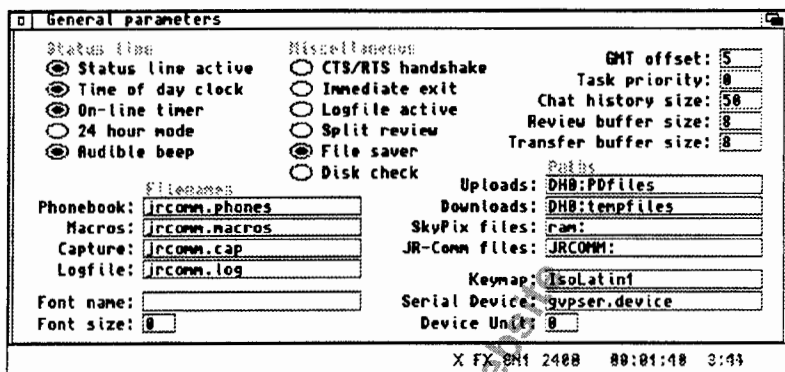

Figure 4.3 – JRCOMM configuration menu window.

- **Save** these settings as the JRCOMM default configuration. When you use JRCOMM, it will address IOExtender Serial port Unit 0. If you try to print files from within JRCOMM or from another program running simultaneously, all calls to the Amiga's printer.device will be rerouted to the second IOExtender port by GVPIOControl and SetDevice.

## Multimedia Presentation System

IOExtenders can also simplify the construction of interactive multimedia systems. Presentation tools, such as Commodore's *AmigaVision* authoring system, provide a means of addressing laserdisc players through the IOExtender's serial ports. In addition, those with some degree of programming experience in high-level languages, such as C and Pascal, can construct even more elaborate control systems.

### Configuring AmigaVision:

- Run *AmigaVision*.

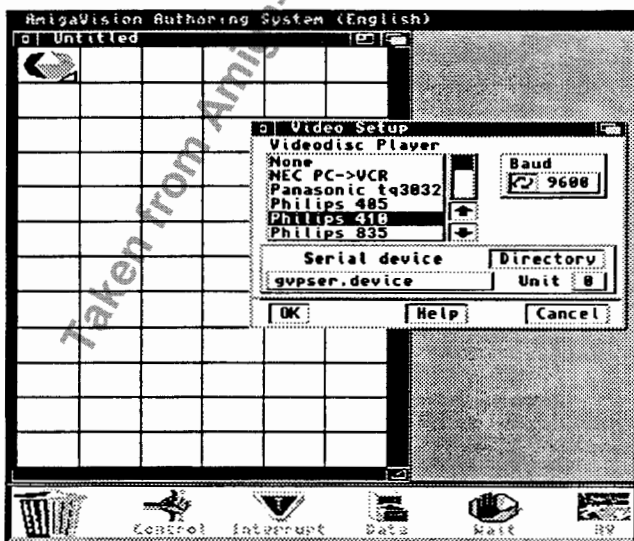

Figure 4.4 – Configuring AmigaVision to use an IOExtender serial port.

- Select the Configuration/Video Setup menu item. A small requester will open, displaying a list of supported video equipment.
- At the bottom of this requester are text entry fields for specifying the name and unit number of a serial device through which AmigaVision will control the selected video player.
- Type `gvpser.device` into the provided text entry field and select the appropriate Unit number.
- **save** these settings. When the program is run, all control sequences sent to the laserdisc or other device will be directed through the specified IOExtender serial port.

## Multi-line Bulletin Board System

A multiple-line Bulletin Board System can be constructed in much the same way as a single-line modem connection. In this case, however, each phone line will be handled by a modem connected to a separate IOExtender serial port. In this way, you can have up to ten lines all serving the same BBS program.

## DSS with a Parallel Printer

Many digitizers access Amiga parallel port hardware directly. These are unaffected by the SetDevice/GVPIOControl redirection program.

Such peripherals actually increase the possibilities for using multiple parallel ports. Ordinarily, when you use SetDevice and GVPIOControl to redirect `parallel.device` calls, you will affect *all* programs that conform to Commodore's recommended programming practices.

Any printing utility or productivity program that expects a parallel printer and any preferences setting tying `printer.device` to the parallel port will, instead, be sending data to the IOExtender port.

Since a digitizing program, such as our own Digital Sound Studio, bypasses the system-level operations and accesses the Amiga parallel port circuitry directly, it will be unaffected by GVPIOControl. If you connect the DSS digitizer to the Amiga's built-in parallel port, it will function normally.



4

(This page left blank)

Taken from Amiga-Manuals-Website

## 5. Troubleshooting

Before calling GVP for technical support help, please complete the following troubleshooting steps yourself:

- 1) Check all cable connections.
- 2) Verify that the external device (*printer, modem, etc.*) you're connecting to the IOExtender works properly when it's connected to the Amiga's built-in I/O port.
- 3) Re-install the IOExtender software.
- 4) Reboot the Amiga and try using the IOExtender software again.

Listed below are some additional solutions to typical interface problems:

### **PROBLEM**

---

- Amiga does not boot.

### **SOLUTION**

---

- After installing the IOExtender, check all cables—including power and video—to make sure they are attached.

### **PROBLEM**

---

- Serial printer does not work.

### **SOLUTION**

---

- Make sure the cables are properly connected.
- Make sure the baud rate, parity, and stop bit settings are the same for both the IOExtender and the printer.
- Make sure the printer is powered ON.
- Make sure the printer is ON-LINE.

### **PROBLEM**

---

- "Garbage" occurs during communications transmission or reception.

### **SOLUTION**

---

- Make sure the baud rate, parity and stop bit settings are the same for both the IOExtender and the modem and/or the host computer.

### **PROBLEM**

---

- Serial port opens, but no data is transferred.

### **SOLUTION**

---

- Check user documentation, if possible, to see if the use of a "null-modem" serial cable may be required. Instead of using a null modem cable, you may elect to change the serial port Null Modem configuration jumpers (*See Chapter 2 for details*).



- Try disabling the CTS/RTS flow control option.

---

**PROBLEM**

---

- Parallel port does not open.

---

**SOLUTION**

---

- Make sure the file *GVPIO* is in the Expansion drawer.
- Make sure the “binddrivers” command has been executed (*usually done during startup*).

---

**PROBLEM**

---

- Serial port does not open.

---

**SOLUTION**

---

- Make sure the file *GVPIO* is in the Expansion drawer.
- Make sure the “binddrivers” command has been executed (*usually done during startup*).



### PROBLEM

---

- `GVPPar0`: does not work.

### SOLUTION

---

- Make sure the port handlers—located in the file “gvpporthandler”—have been placed in the `L:` directory.

### PROBLEM

---

- `GVPSer0`: does not work.

### SOLUTION

---

- Make sure the port handlers—located in the file “gvpporthandler”—have been placed in the `L:` directory.

### PROBLEM

---

- Printouts go to the wrong port.

### SOLUTION

---

- Make sure that `SetDevice` has been run.
- Check all the settings in the `GVPIOControl` program.



## A. Service & Support

### General Information

GVP supports hardware and software products through our network of Authorized Dealers. We strongly recommend you work with your supplying dealer first to resolve problems you may encounter. GVP Authorized Dealers have access to significant technical information and support from GVP and in most cases will offer the fastest solution.

If necessary, you can get assistance from GVP's Technical Support department via fax, telephone or mail:

**Fax** (215) 337-9922 24 hours

**Phone** (215) 354-9495 9:15 a.m. – Noon  
(Phones closed Noon to 1:45)  
1:45 p.m. – 6:00 p.m.  
(all times U.S. Eastern)

**Mail** Great Valley Products, Inc.  
657 Clark Ave.  
King of Prussia, PA 19406

A



## Electronic Assistance

GVP provides a 24 hour Bulletin Board Service (*BBS*) where the latest patches and public release updates are maintained. Access is immediate for first-time users. Call (215) 337-5815 (8, N, 1).

## CompuServe Information Service

Technical assistance, as well as product information, is available on **CompuServe** (CIS).

Type GO GVP at any prompt or send direct EMail to GVP Tech at 72662,51.

## Reporting Problems

If possible, try to determine if the problem is repeatable (*i.e., it occurs under predictable conditions*), and be prepared to describe in detail the particular symptoms and the system configuration in use when it happens.

A





### Your Configuration

AMIGA MODEL \_\_\_\_\_

Motherboard Revision \_\_\_\_\_ Chipset Version \_\_\_\_\_

Kickstart (ROM) Version \_\_\_\_\_ Workbench Version \_\_\_\_\_

CPU Model \_\_\_\_\_ Clock Speed \_\_\_\_\_

Expansion products installed (including competitors' products):

CPU Slot \_\_\_\_\_

Video Slot \_\_\_\_\_

Expansion Slot #1 \_\_\_\_\_

Expansion Slot #2 \_\_\_\_\_

Expansion Slot #3 \_\_\_\_\_

Expansion Slot #4 \_\_\_\_\_

Expansion Slot #5 \_\_\_\_\_

Expansion Slot #6 \_\_\_\_\_

Expansion Slot #7 \_\_\_\_\_

List all hard and floppy drives attached to your system, with Unit ID numbers, manufacturers and capacities, plus any other peripherals:

**A**

---

---

---

---

---

---

---

---

---

---

**INDEX**

---

**A**

A2000 G-Force '040 .....	1.5, 1.6
Application Examples .....	4.1
AUX .....	3.4

**B**

Basic Hardware .....	1.3
Baud Rate .....	3.7
BBS .....	4.6
Bits/Character .....	3.10
Bulletin Board System .....	4.6

**C**

Configuration .....	2.1
AmigaVision .....	4.5
Null Modem .....	2.4
Parallel Port .....	2.3
Connectors .....	1.2
DB-25 .....	1.2
DB-9 .....	1.2
CUSTOM .....	3.8, 3.13
Customer Service .....	A.1

**D**

DB-25 .....	1.2
DB-9 .....	1.2
Default Parallel Port .....	3.5
Default Serial Port .....	3.3
Digital Sound Studio .....	4.7
DSS .....	4.7

**E**

Edit Menu .....	3.12
EVEN .....	3.10
Exiting GVPIOControl ....	3.6
Exiting GVPSerial .....	3.13
External Port .....	2.4
Connections .....	2.5

**G**

Getting Started .....	2.1
GVPIOControl .....	3.2
Effective Use .....	3.6
Exiting .....	3.6



GVPSerial Preferences ....	3.7
Baud Rate .....	3.7
Bits/Char .....	3.10
CUSTOM .....	3.8
Exiting .....	3.13
Handshaking .....	3.9
Input Buffer Size .....	3.8
MAXIMUM .....	3.8
Menus .....	3.12
MIDI .....	3.8
Stop Bits .....	3.11
Unit Number .....	3.11

### H

Handler .....	1.8, 3.1
Handshaking .....	3.9
Hardware Installation .....	2.6

### I

Input Buffer Size .....	3.8
Installation Procedure .....	2.6
Introduction .....	1.1
IOExtender Uses .....	1.7

### J

Jumpers .....	2.1
Default Settings .....	2.2
Pin Numbering .....	2.3

### L

Last Saved .....	3.12
------------------	------

### M

MARK .....	3.10
MAXIMUM .....	3.8
MIDI .....	3.8
Miscellaneous Menu .....	3.12
Modem .....	4.1
Multimedia System .....	4.5

### N

NONE .....	3.10
Null Modem Option .....	2.4
ODD .....	3.10

### P

Parallel Port .....	2.3
Configuration .....	2.3
Parallel Printer .....	4.7
Parity .....	3.10
PC AT .....	1.2
Port Assignments .....	1.5
Preferences .....	3.7
Problem Reporting Form ..	A.3
Product Overview .....	1.1
Project Menu .....	3.12

**Q**

Quit ..... 3.12

**R**

Reset ..... 3.12  
Restore ..... 3.12,  
3.13  
Ribbon Cable ..... 2.5  
RS-232 ..... 1.2, 1.4  
RTS/CTS ..... 3.9

**S**

Save As... ..... 3.12  
Serial Port Connector ..... 3.4  
Serial Printer ..... 4.1  
Set Custom Baud Rate ..... 3.13  
SetDevice ..... 3.1, 3.2,  
4.7  
Software Compatibility ..... 1.6  
Software Installation ..... 2.9  
Software Reference ..... 3.1  
SPACE ..... 3.10  
Stop Bits ..... 3.11  
System Architecture ..... 1.4

**T**

Troubleshooting ..... 5.1

**U**

Unit Number Selection ... 3.3, 3.5

**X**

XON/XOFF ..... 3.9





(This page left blank)

*Taken from Amiga-Manuals-Website*



GREAT VALLEY PRODUCTS, INC.

657 CLARK AVE.

KING OF PRUSSIA, PA 19406

USA

ioExtender is a trademark of Great Valley Products, Inc. Amiga is a trademark of Commodore-Amiga, Inc.

©1993 Great Valley Products, Inc.  
All rights reserved.