

Phoenix Board Manual

Version 1.3

Phoenix Microtechnologies Pty. Ltd.

18 Hampton Rd Keswick South Australia 5035

Phone: (08) 293 8752 Fax: (08) 293 8814 Intl. +61-8

ACN 008 268 595

Contents

Introduction	1
Chapter 1	2
Features of the Phoenix Board	
Chapter 2	7
Installing the Phoenix Board	
Chapter 3	18
Testing and Problem-Solving	
Chapter 4	21
Installing the Hard Drive	
Appendix A	31
Link Configurations	
Appendix B	33
Memory Options	
Appendix C	35
Model Variations	
Appendix D	36
Kickstart ROMs & Swap Switches	
Appendix E	42
Phoenix Drive Swap Switch	
Appendix F	44
Maths Co-Processor	
Glossary of Terms	45
Service Guidelines	47
Acknowledgements	49

Introduction

Congratulations on purchasing your Phoenix Board! We hope that it will perform to your highest expectations, resulting in a more powerful and useful Amiga 1000.

This documentation is organised in the following fashion:

Chapter 1 covers the features of the Phoenix Board in detail, including standard features and accessories.

Chapter 2 covers the installation of the Phoenix Board. If your Phoenix Board is to be installed by Phoenix MicroTechnologies or another approved installer, you should be able to disregard this section.

Chapter 3 gives some guidelines to testing and trouble-shooting your Phoenix Board. If you did not install the board yourself, you should gather as much information as possible using this chapter before contacting the installer regarding difficulties.

Chapter 4 covers in detail the installation of a hard drive using the built in SCSI Controller.

Appendix A describes the manner in which the various links on the Phoenix Board should be set for the standard configuration and with each option installed.

Appendix B explains the possible memory configurations of the “Phoenix Board” with either 1Mb or 2Mb installed on the motherboard.

Appendix C lists the variations between Amiga 1000s as regards both installation and operation of the Phoenix Board.

Appendix D describes all the possible Kickstart choices offered by a Phoenix Board, and how the Kickstart Swap Switch is installed and used to select them.

Appendix E describes the installation of a Drive Swap Switch.

Appendix F describes the installation and usage of a Maths Co-Processor.

Also included in your package are the following items:

- A support disk titled “**Phoenix Board**” which contains technical documentation too extensive or specific for this manual, as well as useful utilities.
- The **Service Guidelines** section at the end of this document explains our service procedure and fault liability policy. Please read this carefully before contacting us to report a product fault
- A **blue warranty card**, which you should fill out and return as quickly as possible. Your warranty will not be valid unless we receive this card.
- A **transparent blue sticker** for the front panel of your Amiga and a **printed paper sticker** for the underside of the case which shows the serial number of your board.
- A small plastic bag containing 5 links, should you misplace any provided with the Phoenix Board or its options.
- Any options kits you purchased with your board with their accompanying documentation, disks and chips, as well as other separate items such as a hard disk.

We would appreciate feedback on any aspect of this documentation you find lacking.

Chapter 1

Features of the - Phoenix Board

Your Phoenix Board is equipped with the following features:

- **Full support for the Enhanced Chip Set** (Obese Agnus standard)

Unlike the old Fat Agnus in early Amiga 500s and 2000s, and the even older 48-pin Agnus in Amiga 1000s, the Obese (or Super) Agnus allows up to one megabyte of chip (graphics) memory. The earlier Agnus chips, which allowed only 512k of chip memory, severely limited the number and complexity of graphics operations that were possible. For example, Deluxe Paint's™ 640x512 16-colour interlaced screen could be used, but there was not enough chip memory left over for the undo feature or the alternate screen.

Other features offered by the Obese Agnus include the ability to do “blits” (the copying or moving of an area of memory by the chip itself) of a much larger size than was previously possible. This means that less time is needed to manipulate large graphic objects, leading to faster operation of some programs.

The Super Denise chip is pin-compatible with the earlier Denise in the A1000. It offers two new graphics modes in conjunction with the Obese Agnus. The **Super-Hires** mode produces 1280 pixels across the screen; the **Productivity Mode** displays 480 lines down the screen using only 4 colours, without interlacing. A multisync or VGA monitor is required for Productivity mode. This chip is not standard with the Phoenix Board as the original Denise is transferred from your A1000 at the time of installation.

Other custom chips may be revised in the course of time. All will be available from Phoenix Microtechnologies when released by Commodore.

- **Kickstart 1.3 ROM**

The Phoenix Board comes standard with a Kickstart 1.3 ROM; this revision of the operating system is by far the most widely used, and is extremely stable. It differs from 1.2 mainly in that it allows autobooting from hard disks (such as one connected to the Phoenix Board's SCSI port) and the RAD: ramdisk. Earlier Kickstart revisions are somewhat unreliable and buggy, and should only be used to run software which fails on later versions. “Setpatch option r” must be used in your startup-sequence for the RAD: to work.

The Phoenix Board can hold four Kickstarts, any two of which can be selected with the Kickstart Swap Switch. This can include the Version 2.0 ROM, soon to be available from us. Please see Appendix D for more information regarding Kickstarts.

- 2Mb of RAM on the Motherboard (1Mb Chip and 1Mb Fast)

The Phoenix board comes standard with 2 megabytes of RAM on the motherboard, which is normally configured as 1 megabyte of chip RAM and 1 megabyte of fast RAM. Various memory configurations are possible - please see Appendix B for details.

Commodore has released an even newer Agnus chip (colloquially known as the Super Obese Agnus), which supports 2 megabytes of chip memory. The Phoenix Board will support this chip. This chip and the necessary 1Mb x 4 DIP DRAM memory chips will be available as an upgrade in the near future.

- Internal SCSI Port

The SCSI Port consists of several chips (including a custom-programmed PAL and autobooting driver EPROM), a disk containing support software and full documentation. A DB25 SCSI cable extension kit (AP1001-HE) and mounting kit (AP1001-BK) are also available.

We also sell 1" high (low-profile) Quantum SCSI hard disks (52Mb and 105Mb sizes readily available) which can be fitted inside the A1000's case. An AP1001-BK Mounting kit is required to mount this drive internally. This kit contains Power and Data cables, a Template, and Mounting Brackets. Larger capacities may only be available in taller drives which must be located externally

- B2000-Compatible Expansion Slot

This slot is designed to work with all standard B2000 expansion cards, many of which offer facilities not available for the A500 and A1000. Socket U70 has a "P70" PAL fitted and all three links in L117* removed. Also link L15* must be removed and links L18 and L19 must be fitted. If the card does not work correctly, consult Chapter 3. *If there is a card plugged in

- B2000-Compatible Video Slot

The Phoenix Board has an A2000-compatible video connector which accepts a genlock, FlickerFixertm, Display Enhancer etc. This slot includes all signals present on the A2000's video slot.

- Internal RS-232 Connector

A dual-row header connector (as found in the A2000) allows any standard RS232 device, such as a MIDI interface or a modem, to be fitted internally. Note, however, that because this is a duplicate of the A1000 Serial Port pin outs, A2000 Serial Port peripherals will need modification to match them. This connector allows 2 serial devices to be connected, but only allows 1 to be used at any one time, they cannot both be used at the same time. Contact Phoenix Microtechnologies for further details.

- Maths Co-Processor Socket

The Phoenix Board has a socket for 68881/ 68882 Co-Processors. A PAL chip is included to enable the function and an appropriate oscillator crystal is required as well as the 6888x Co-Processor chip.

The 68000 CPU is not optimised for mathematical operations, which are executed more quickly by the 68881 and 68882 co-processors. They operate in parallel with the 68000, handling mathematical operations much faster than the 68000 could. This can produce a significant increase in the speed of maths-oriented applications such as Drawing, CAD packages and Ray Tracing programs, and especially those programs that use trigonometrical functions. However, note that programs must use the IEEE libraries supplied by Commodore, which take advantage of the maths co-processor. We can sell you a 68881 maths co-processor and a 12, 16 or 20 MHz oscillator to suit.

- Kickstart Swap Switch

Because ROM upgrades change many things in the operating system, there are some (poorly written) programs and games which do not work with more recent versions of Kickstart. It is for this reason that the option exists to have four versions of Kickstart present in the Phoenix Board.

The Kickstart Swap Switch enables either of two of these Kickstarts to be selected by a supplied toggle switch which can be mounted on the case. Also supplied is a PAL (custom logic chip) required in conjunction with the switch. Please see Appendix D for more details.

The ability to load Kickstart from disk (as was the case with the A1000) can be useful, as it allows new Kickstarts to be used easily (without the need for new ROMs to be created and installed), and it also makes it easier to customise your own Kickstart should you so desire. This function will be supported in later versions of the RAM controller PAL chips. Contact Phoenix Microtechnologies for more information.

- Software Switching of the 7.5kHz Audio Filter

All model Amigas have a high-frequency audio filter which cuts out sounds above 7.5kHz. The filter in the A1000 is fixed in hardware, and can only be disabled with a hardware modification. The filter in the A500, A2000 and A3000, however, is tied to the power light, and is therefore under software control. When the power light is bright, the filter is switched in, and when the power light is dim, the filter is switched out. Refer to L25 in Appendix A.

Switching out the audio filter can dramatically improve the sound produced by some programs; many programs in fact switch the filter out themselves. The Phoenix board has its audio filter tied to the power light in the same manner. Manual switching is also possible.

- Disk Drive Swap Switch

5.25" disk drives are an excellent alternative to standard 3.5" drives because of the low cost of disks and greater reliability. The disk drive swap switch permits booting from a disk drive other than DF0: e.g. a 5.25" drive. This allows you to store all software on 5.25" disks or simply boot from DF1: if DF0: is faulty.

- Internal Real-Time Clock

The standard A1000 and A500 have no built-in real-time clock, which means that every time the Amiga is booted the system clock will be set to a random time. The A501 memory board for the A500 does contain a real-time clock, which is accessed via the **SetClock** program in the startup-sequence. The clock on the Phoenix board operates in the same manner, and is thus fully compatible with those in the A500 and A2000.

- Monochrome Video Output

The Phoenix Board does not produce the composite colour output of the A1000, but rather a monochrome signal which produces optimum results when used on green or amber monochrome monitors. Such monitors produce a sharper image than colour monitors, making them ideal for text-based work.

- Fully Socketed

The Phoenix board is fully socketed. This means that if at any stage chips need replacing or new chips need to be installed no soldering is required, thus avoiding board and chip damage. All chips are simply plugged in.

- Space on Board for an Internal Disk Drive Connector

The Amiga has the ability to support four floppy disk drives, which can be either 3.5" or 5.25" types. On the A1000 and A500, the connector for DF1: (the second disk drive) is external, and DF2: and DF3: are daisy-chained onto DF1:. On A2000s and A3000s, DF1: is internal, and the external connector is for DF2: and DF3:.

The Phoenix board has space on it for an internal DB23 connector to be soldered to it. This connector is identical to the external drive connector and will allow your external drives to be mounted internally in a larger case. It is not soldered in as standard.

Use of a Larger Case

Some of the above features which allow peripherals to be mounted inside a case containing the Phoenix Board may require that the case be larger than the A1000's original case.

Phoenix Board Accessories

The following accessories may also be included with your board. If not, they may be ordered separately from us at any time. **No accessories require soldering.**

- Internal 8 Megabyte Daughterboard (In Design) AP1001-D

As well as the maximum 2 megabytes on the actual Phoenix board itself, an internal 8 megabyte daughterboard will soon become available. This board will connect to a special socket on the Phoenix board, and so should not interfere with any other external expansion devices. The board will accept up to 8 megabytes of RAM, and can be populated in 2Mb/4Mb/8Mb steps.

- Soldered Connector Cable Set AP1001-PC

Some A1000's have their connectors soldered to the main board. For those people who have this version board, a cable set is available to replace the soldered cables. It is not enough to desolder the cables, as new connectors are required for the cables, in order to work with the Phoenix Board. Do not attempt to use other cables.

- Hard Drive Mounting Kit AP1001-BK

This kit contains mounting brackets, data cable, tri-coloured LED and a template for installing a 1" high hard drive inside the original A1000 case. The template is for Quantum LP52S and LP105S hard drives, and any other 1" high hard drives which use the standard mounting holes in the hard drive casing.

- SCSI Extension Cable AP1001-HE

This cable allows you to plug in extra SCSI devices into the Phoenix Board SCSI controller. One end plugs into the 26 pin header (JP4) on the board, and the cable terminates at the other end with a standard 25 Pin SCSI DB connector, which can be mounted on the rear panel of the A1000 case, or passed through an existing or new hole in the case.

- 2Mb Chip RAM System AP1001-SO

This kit consists of four 1Mbx4 DRAM DIP chips, 1 x 2Mb Agnus, 2 jumpers and the necessary instructions for installation.

Chapter 2

Installing the Phoenix Board

This chapter describes the installation process in complete detail. If you are technically experienced you may not need all of this information, but if you are in any doubt at all as to the correct approach to any part of this process PLEASE READ THE APPROPRIATE SECTION CAREFULLY. If you are inexperienced with electronic equipment you MUST read this entire manual before commencing. We strongly recommend that ALL people read the entire manual before commencing. If you are still unsure of your ability please contact us or one of our approved installers to arrange installation. The installation fee is a small price to pay compared to the possible expense of chip or board damage.

Unpacking the Phoenix Board

Your Phoenix board comes packed in an anti-static bag which we use to protect the board and its chips from electrostatic damage. Please leave the board in this bag until you are ready to transfer it to the installation environment described below.

The floppy disk contains additional documentation and diagnostic programs for the Phoenix board, and various utilities that you may find useful. However, all information you need to install the Phoenix Board is contained in this printed document.

If your Phoenix board is to be installed by anyone other than Phoenix Microtechnologies, you may disregard the rest of this chapter. Simply deliver the board (in its anti-static bag), and manual to the installer, along with your Amiga 1000.

Work Area Preparation

Most of the chips on the Phoenix Board and in your original A1000 are EASILY DESTROYED BY STATIC ELECTRICITY, which is generated by walking on carpet, the rubbing of clothing etc. Following these guidelines will virtually eliminate the possibility of static damage occurring:

- The best working surfaces are anti-static mats or sheets of conductive foam, but a metal surface, preferably a kitchen sink or solid metal sheet, is a good substitute. If you use a sheet of aluminium foil, take care that fragments of it aren't stuck to or embedded in the pins on the back of the Phoenix Board when you install it.
- If you use a metal work surface, ensure that it is well clear of all mains wiring. Sharp corners can easily puncture wiring insulation.
- Ideally you should attach yourself to your working surface with a conductive wrist strap (available from Electronic shops). Otherwise, touch the work surface frequently, especially while placing or removing a chip.
- When chips are not in their sockets place them on the metal sheet Do not let them come into contact with clothing or plastic.

Rear

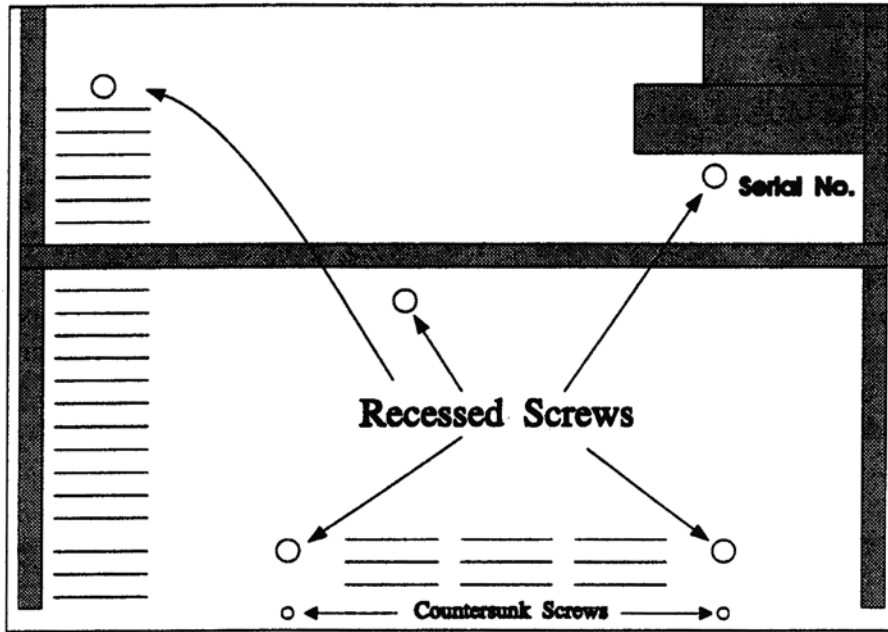

Figure 2-1
Underside of Amiga 1000

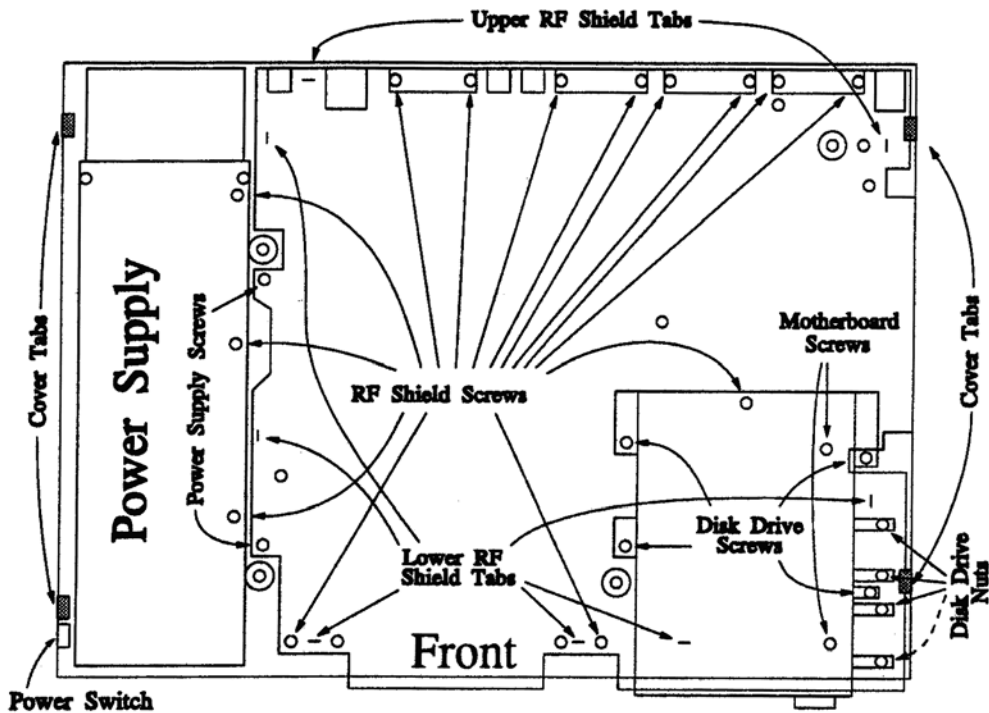

Figure 2-2
Amiga 1000 Top View

- If passing a chip or board to someone else, touch his/her skin before doing so. This eliminates any relative static charge between you.
- Touch the metal casing of one of the mouse/joystick connectors at the side of the Phoenix Board or original A1000 motherboard before inserting or removing chips.

All these measures are intended to eliminate any static being discharged across the chips and boards you are working with. Nothing as dramatic as a spark is required to destroy or subtly damage chips!

You will need the following tools to carry out the installation process:

- A medium flat-blade screwdriver
- A medium-sized Phillips head (crosspoint) screwdriver, preferably magnetic;
- A small flat-blade screwdriver
- A small coin;
- A pair of long-nosed pliers;
- About ten small containers to hold screws and nuts.

Disassembling the A1000

Disconnect all cables from the A1000 and take it to your prepared work area. Turn the A1000 upside down, with the front facing towards you. Referring to Figure 2-1, remove all seven screws shown and store them in one of the containers. Keep these screws separate from the similar internal ones, which have a coarser thread. Do not be concerned if the material holding the front two countersunk screws is stripped, since these do not play much part in holding the A1000 together.

Turn the A1000 upright again with the front facing towards you. To remove the top cover you must release four plastic catches near each corner of the machine, in the positions shown in Figure 2-2. They are located inside the top cover and are not readily visible from outside. You may be able to see a slight mold mark in the gap between the top and bottom halves at the points where they are located, but this is not important. Place the coin horizontally in the slot between the top and bottom halves at each point and, pushing gently inward, move the outer edge of the coin downwards; this should release the catch. Lift the cover off and put it aside (the signatures embossed on the underside are those of the people who developed the Amiga in 1984!)

Remove the fourteen screws holding down the upper RF shield which covers the motherboard, whose locations are shown in Figure 2-2. There are several different screw types within this group, which should be kept separate:

- Three roundhead 3mm ISO metal thread screws along the power supply;
- A countersunk 3mm ISO metal thread screw at the rear of the disk drive;
- Eight tin-plated "silver" self-tapping screws along the rear edge of the board;
- Two gold (cadmium-plated) self-tapping screws at the front of the board.

Untwist the two Upper RF shield metal tabs near the rear of the board (shown in Figure 2-2) which hold the upper RF Shield to the motherboard with the long-nosed pliers. Carefully lift the upper RF shield free of the motherboard and put it aside.

At this point the A1000's chips are accessible and subject to static damage. Remember to follow the guidelines previously mentioned while touching or handling them.

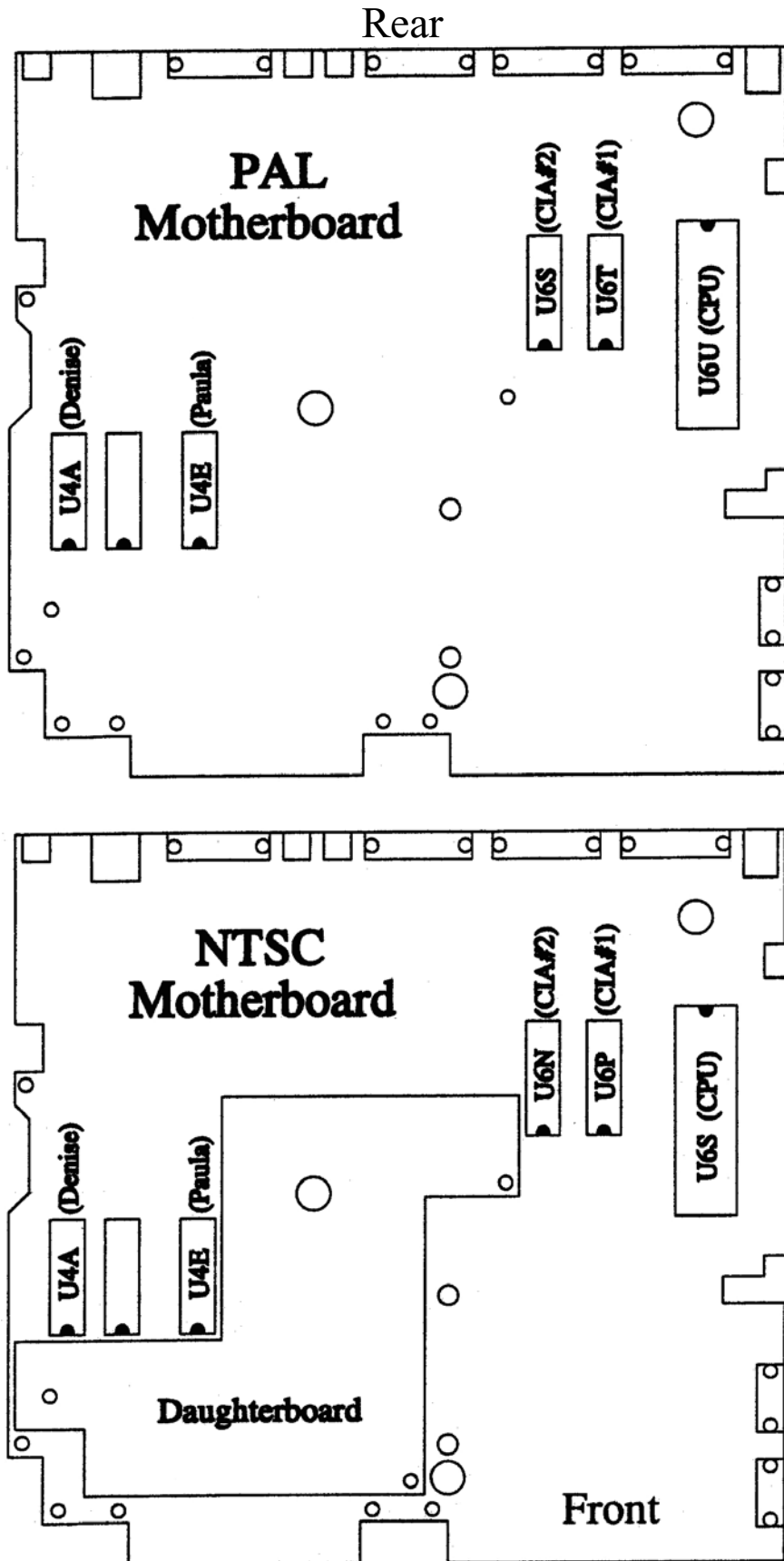



Figure 2-3

PAL & NTSC Motherboards

*** Before going any further please check three things:**

1. *If your 68000 CPU is manufactured by Thomson ( symbol on chip) or Hitachi () then problems of overloading the bus may occur. As the Phoenix Board's SCSI controller and Expansion slot are in effect loading the bus, it is likely that problems will occur. We strongly advise all people to change the CPU to a "Motorola" type to avoid problems.*
2. *Check to see if your floppy disk drive data and power cables are soldered to the main board. Not applicable to NTSC machines. If they are, please consult appendix C and page 6, as you will be required to purchase a Soldered Connector Cable Set (AP1001-PC). Refitting connectors is not advised, and will void your warranty if any damage occurs.*
3. *Check to see if your internal floppy disk drive is an "NEC" or "Matsumi" brand. If it is one of these brands, please consult Appendix C as you will have to replace it.*

Disassembling the A1000 Continued.....

Remove the plastic cover from the 256K expansion cartridge at the front by squeezing it between two fingers placed in the centre of the upper and lower edges and pulling outward. A fair amount of pressure may be required to do this. Remove the two screws at the lower corners of the cartridge's circuit board and remove it from the edge connector on which it is seated. This cartridge **MUST UNDER NO CIRCUMSTANCES BE ATTACHED TO THE PHOENIX BOARD**. Carefully remove the front panel of the Amiga by pulling the top outward and down, allowing the clips that hold it at the bottom to disengage. With the panel now lying face down, cut the cable tie and carefully unclip the power and disk drive lights (LEDs) from the front panel, taking care not to bend the wires connected to the LEDs near the body of the LED since they tend to snap off easily. Unplug the power LED from the motherboard and put it aside. If the power LED will not unplug and is soldered to the board, consult Appendix C now.

Disconnect the power supply from the motherboard. Note the orientation of the connector, with the grey lead towards the rear of the machine. Also disconnect the power connector and 34-way ribbon cable attached to the internal disk drive from the board (Note - if these cables are soldered to the motherboard in your A1000, please consult Appendix C NOW, as you will need to obtain an AP1001-PC cable kit). The red stripe on the 34-way cable should be on the right hand side; it must be oriented in the same manner when installed in the Phoenix Board.

Unbolt the disk drive, which is held by the four gold self-tapping screws and four slotted brass extension nuts shown in Figure 2-2. Carefully lift the disk drive free of the motherboard. Unclip the earth lead between the disk drive and the motherboard and put the drive assembly aside. The cable tie holding the drive light to the board needs to be cut. The spade connector which the earth lead attaches to on the drive and the mounting screw should be removed to avoid the possibility of them shorting to components underneath it on the Phoenix Board.

The remaining screws and metal tabs holding the motherboard are now exposed. Remove the two tin-plated silver self-tapping screws holding the board and the power supply on the left hand side (marked "Power Supply Screws" in Figure 2-2) and the two gold self-tapping screws near the right hand side of the board beneath where the disk drive was located (marked "Motherboard Screws" in Figure 2-2.)

Rear

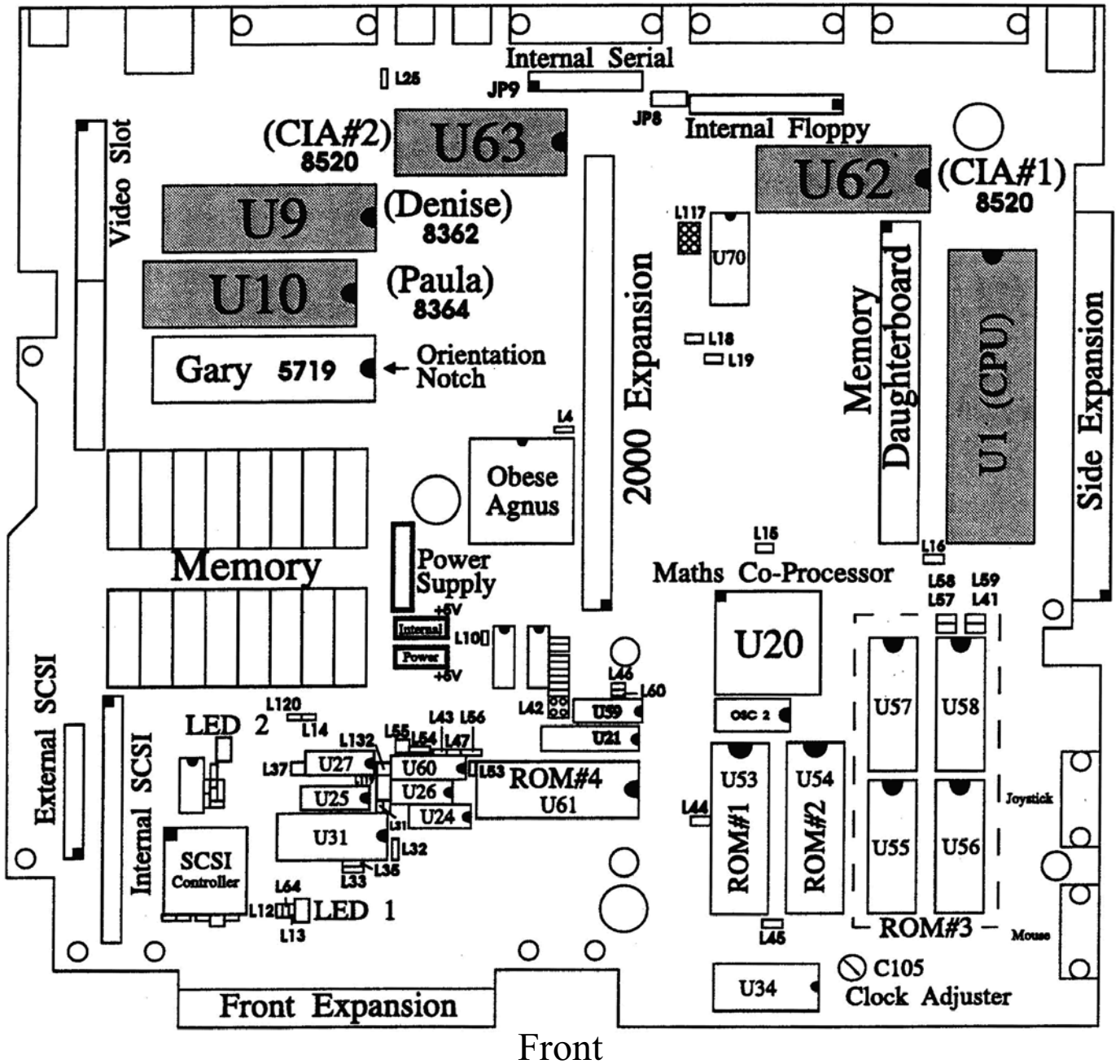

Figure 2-4
Phoenix Board
Major ICs and Connectors

Removing the Integrated Circuits to be Re-Used

There are 5 chips which need to be removed from the original A1000 motherboard and inserted into the Phoenix Board. Each is listed below, along with its part code (printed on the chip) and designation on either type of original motherboard and the Phoenix Board (printed on the board). The NTSC motherboard differs from the PAL version in that it has a large daughterboard in the front left quarter of the board, as shown in Figure 2-3. Remove this daughterboard if it obstructs the removal of any of these ICs. Figure 2-3 also shows the location, orientation and designation of each of the chips to be removed.

Code	Name	NTSC (daughterboard) Designation	PAL (no d'board) Designation	Phoenix Board Designation
68000	CPU	U6S	U6U	U1
8520	CIA #1	U6P	U6T	U62
8520	CIA #2	U6N	U6S	U63
8364	PAULA	U4E	U4F	U10
8362	DENISE	U4A	U4A	U9

Remove each chip by the following method. Carefully place the blade of the screwdriver between the chip and its socket, not the socket and the board. Gently work the blade underneath the chip keeping the blade as flat as possible. Be careful not to allow the blade to contact the motherboard underneath. The blade should always remain as flat as possible. (See Figure 2-5) Gently rock the blade from side to side to help lift the pins along each side of the chip, keeping the chip as level as possible. Gradually work the blade to the opposite end of the chip, until it is free of its socket. Examine them carefully and straighten any bent pins with the pliers, making sure to touch both the chip and the pliers to your work surface first. DO NOT touch the IC pins with your fingers. Put the chips in a safe place on your work surface.

Removing the motherboard

It is now time to remove the original motherboard from the case. If you have any special cards, switches etc. fitted you may need to unplug or remove them to achieve this. The six metal tabs holding the lower RF shield to the underside of the motherboard must be straightened. These are marked "Lower RF Shield Tabs" in Figure 2-2.

Lift the right hand side of the motherboard, pushing the right hand side of the case out slightly to free the mouse/joystick connectors. Excessive force should not be required. Continue lifting the right hand side of the board, pulling gently to the left. The back panel of the case should be removed with the board and put aside. Gently separate the lower RF shield and mylar sheet from the board and keep them together.

The metal guard which surrounds the expansion connector should be removed (it is held in place by a nut and bolt at each end) and fastened to the Phoenix Board in the same manner. Only the right hand expansion port metal guard should be re-attached. The front one should be discarded.

Installing the ICs in the Phoenix Board

Please follow the chip handling guidelines near the beginning of this chapter while handling these chips. Make sure that the Board is lying on a flat smooth surface so that it does not flex or bend with the pressure of inserting the chips. Please note; if the pins on the chips do not align with the socket holes, do not force them, but refer to chapter 3, page 20, for instructions.

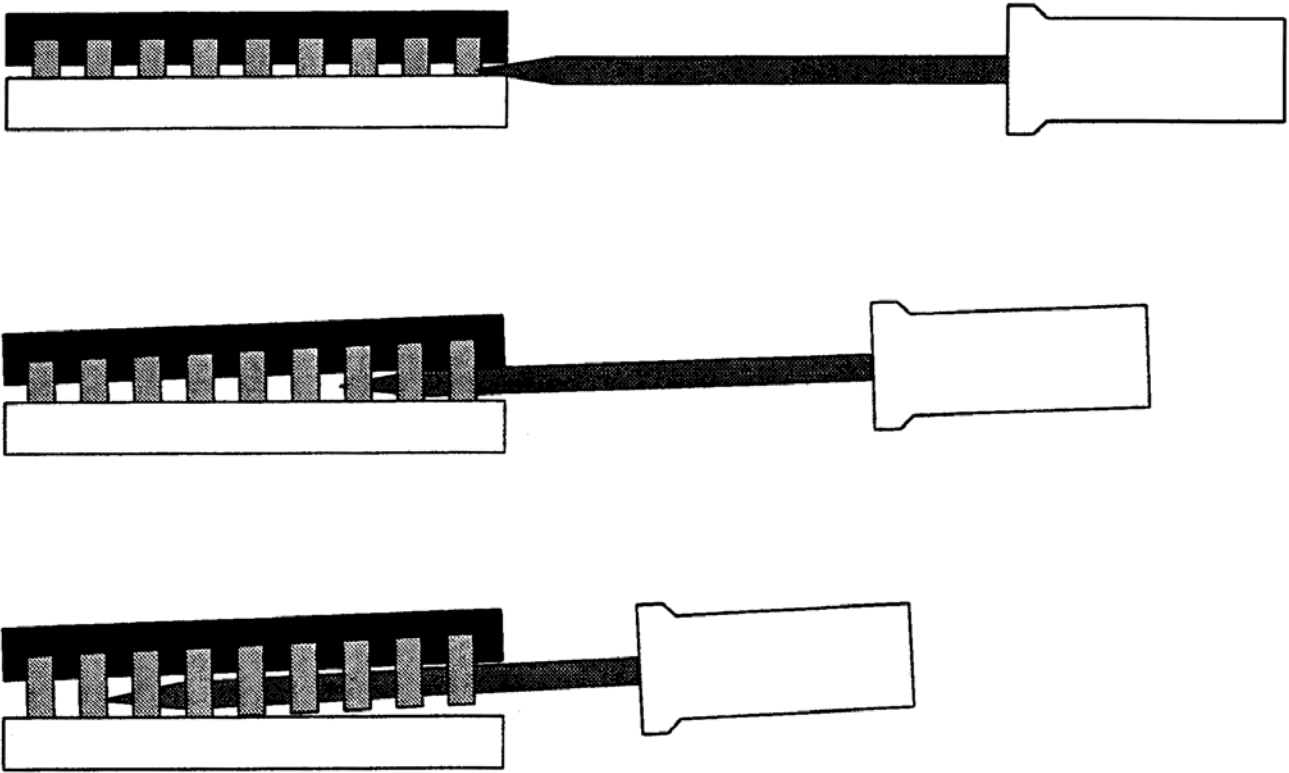
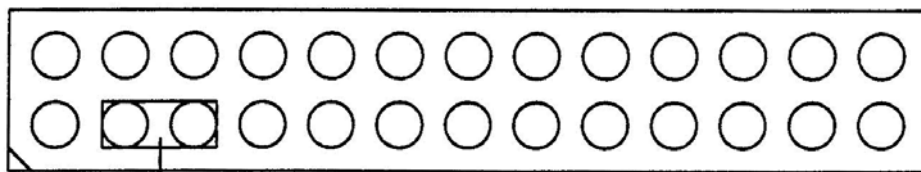

Figure 2-5
Chip Extraction



Link

Figure 2-9
JP9 Connector

Carefully install the chips removed from the old motherboard in the Phoenix Board as shown in Figure 2-4, noting the orientation of each; the semi-circular notch in one end of each chip corresponds to a similar marking in the diagram. Place each chip lightly onto its socket and ensure that all pins are located correctly before applying pressure evenly from both ends of the chip to seat it. Take particular care with the 68000 CPU, which will require more force due to its larger size. Once the chips are seated, check again for bent or damaged pins.

Case Preparation

Before installing the Phoenix Board into the waiting case, perform any case modifications relating to switches etc., such as drilling 1/4" holes for Kickstart & Drive Swap Switches (as well as any other switches you intend to install) and modifying the upper RF shield to accommodate an internal hard disk or other cards. Perform these modifications away from the Phoenix Board work area to avoid contamination or damage to the board. Please read appropriate sections on fitting accessories.

We advise that you mount switches in the right hand corner on the rear panel well above the RF shield, parallel port and keyboard connector, as this placement will allow for maximum flexibility of adding cards, hard drives, accelerators etc., inside the original case. If you mount these switches underneath the front expansion connector panel do so along the top right hand corner to avoid interference with future cards intended for this connector, and the RF shield.

If you are installing a Hard Drive, please read chapter 4 before going any further.

Clean the inside of the case thoroughly to remove plastic and metal fragments. You are now ready to install the Phoenix Board!

Installing the Phoenix Board

- 1 Tie or tape back the power supply cable out of the way of the board.
- 2 Place the lower RF shield on the underside of the Phoenix Board, making sure that the thin mylar sheet is between them. If this sheet is missing or damaged DO NOT INSTALL the lower RF shield as SHORT CIRCUIT DESTRUCTION of the power supply or motherboard will certainly result.
- 3 Check the alignment of the mylar sheet with the holes in the circuit board and twist the six metal tabs that hold the lower RF shield to the board. DO NOT twist the two tabs at the rear which also engage the upper RF shield at this point. Read "Initial Testing" (page 16) before replacing the Upper RF Shield.
- 4 Rub the 84 way edge connector very lightly on both sides with a lint-free tissue or cotton bud dampened with alcohol or methylated spirits to clean it. The expansion connector is prone to making unreliable contact with plug-in boards if it has been contaminated by residues from skin contact or dust
- 5 Put the back panel onto the board making sure all connectors are fully engaged in their appropriate places. Carefully lower the board and back panel over the mounting posts, making sure that the connectors remain fully engaged, and the back panel slides into its slots at both ends. Make sure that the power supply mounting tabs are below the board, and that no wiring is trapped beneath the board.
- 6 At this point the case prevents the mouse and joystick connectors from sitting in their correct position; carefully ease the case out to allow them to slip into the holes in the case.

Reassembling the computer

Reassembly is a reversal of the disassembly process. Refer to Figure 2-4 for the location of the connectors described here.

Bolt the board to the case and power supply using the 2 silver PK screws for the “power supply” and the 2 gold PK screws at the location marked “motherboard screws” in figure 2-2. Next bolt the disk drive to the board with the four gold PK screws and four slotted brass extension nuts. Discard the earth lead, and its screw and connector from the underside of the drive. Make sure all components are clear of the bottom of the drive. (If you have a NEC or Matsumi drive please consult appendix C). Connect its 34-way ribbon cable to the “Internal Floppy” connector (JP7) near the rear of the board and its 4-way power cable to one of the “Internal Power” connectors (JP2 or JP3) near the centre of the board. Make sure the polarity is correct. Do not force the connector. It will go in easily when polarity is correct, and it is straight.

Plug the power LED into the “Power LED” connector (LED 1) near the front left front corner of the board. (See figure 2-4). The polarity mark should face towards the rear. Please refer to chapter 4 (figures 2.7 & 2.8) if you have a hard disk drive installed.

Reconnect the power supply to the Phoenix board, checking the orientation of the connector. Make sure the locking ridge on the power supply connector faces away from the power supply (grey wire towards the rear), and is pushed fully home past the nylon clip, and be careful it does not get caught on the side of capacitor C94 as you reconnect it. Clip the power and disk drive LEDs to the front panel and replace it, checking that its tabs mate securely with the underside of the case. **DO NOT INSERT THE 256K RAM EXPANSION CARTRIDGE**, as it will short circuit the board!

Initial Testing

Your Phoenix Board is now ready to run, but before replacing the RF shield and top cover you should reconnect only your necessary peripherals, boot it up and make sure all is well by running “PBTest” and “SysTest”. Please see chapter 3 for instructions on use of these test programs. Run some of your applications and/or games and experiment with the switches. If all seems well plug in all you peripherals and test them out. If you have a hard disk connect it and format it, following the instructions in chapter 4. If you experience problems or wish to test the board thoroughly read the next chapter; please attempt to locate and isolate problems yourself before contacting us.

Before permanently replacing the upper RF shield, apply the supplied self-adhesive tape to the shaded areas shown in Figure 2-6. The tape should be wrapped around the shielding as shown so that there is an even amount of tape on the inside and outside of the shielding. This will stop the shielding from shorting to the top of the Phoenix Board. When you are satisfied that the entire system is functioning correctly, twist the two rear metal tabs and replace the fourteen screws. (See figure 2-2 & page 9 for locations and descriptions. Make sure you use the correct self-tapping type for those on the motherboard; those along the rear of the board are silver (tin-plated) and slightly longer. Make sure that the RF shield is well clear of any switches you may have installed. Clip the top cover back on, and turn the computer over. When replacing the top cover make sure there are no wires trapped between the mounting posts for the top and bottom of the case. Replace the five large recessed and two small countersunk screws.

The final step is to attach the two stickers included to the case. The large blue sticker should be attached to the front panel and the other shows the serial number of your board, and should be located on the underside next to Commodore’s serial number (See figure 2-1). This will assist us in identifying your board if you experience problems or have questions at a later date.

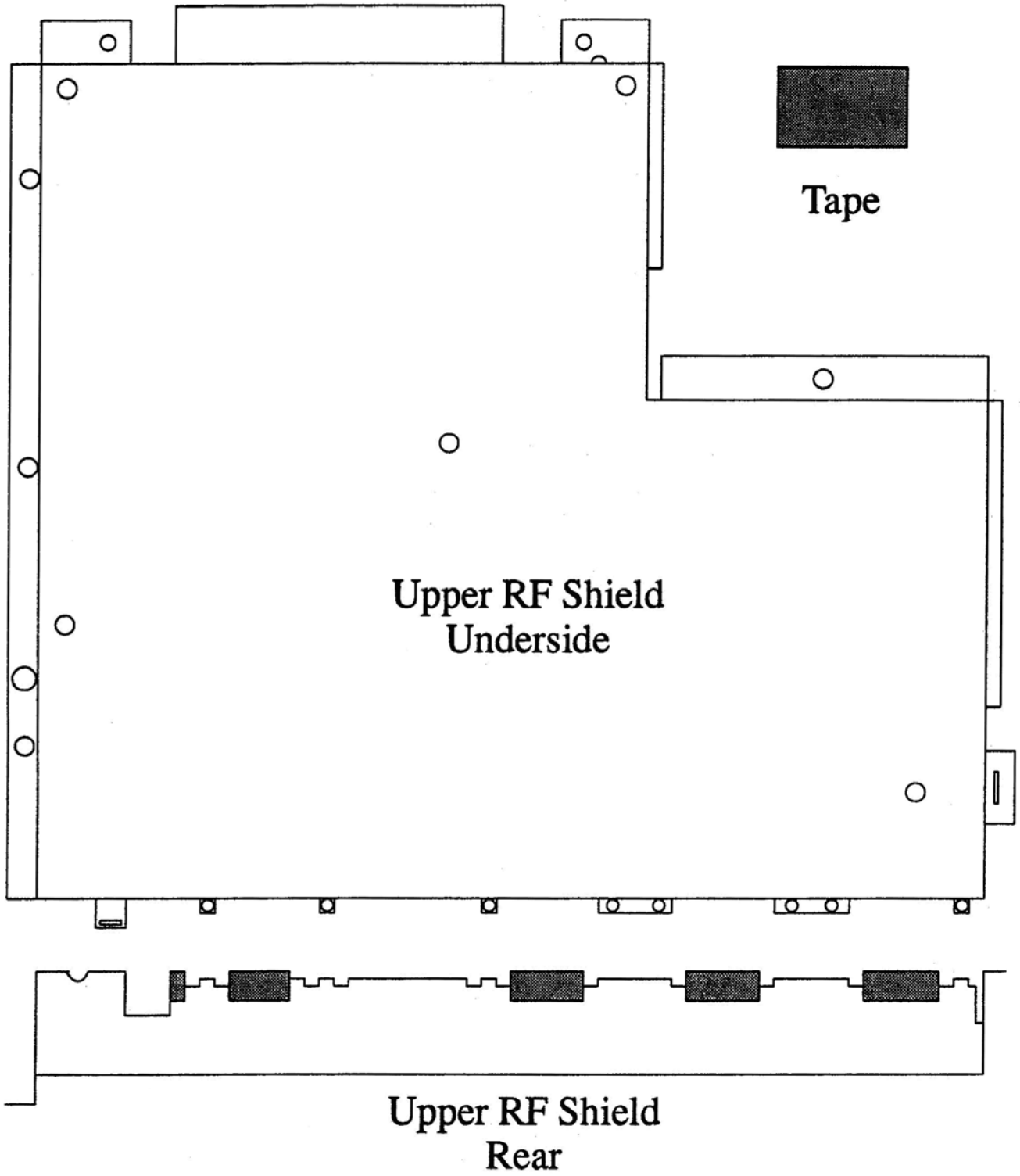

Figure 2-6
Upper RF Shield

Chapter 3

Testing and Problem-Solving

We hope that your Phoenix Board worked correctly in every respect when you first booted it, and that you're only reading this chapter with the intention of fully testing the board! If, however, the board fails to boot or behaves incorrectly in some fashion, don't panic; since your board was heavily tested before being shipped, virtually all problems can be traced to damage during shipping and installation.

Testing

The two programs we use to test the Phoenix Board in-house are included on the supplied disk, along with some documentation describing their use and features. **Systest** tests most of the general functions of an Amiga, while **PBtest**, which was written by us specifically to test the Phoenix Board, covers some different areas. Be aware that many of PBtest's results vary depending on the options installed on your board.

The drive test will fail if only one drive is connected as the software checks for internal and external drives. The serial test will fail if there is no link on JP9 (as indicated in figure 2-9 on page 14). Be sure to remove it after testing and before replacing RF Shield. Type:

Systest ? for instructions / parameters
PBTest ? must be used to get menu list up and running

Visual Inspection

If your Phoenix Board fails to boot or crashes repeatedly without obvious cause, you should first check the condition of the board. Shipping can dislodge chips and connectors and cause floppy drive misalignment. Ensure that all chips are firmly seated in their sockets, and carefully check the five chips transferred from the old motherboard for bent or damaged pins or incorrect orientation. If in doubt, remove the chip and re-install it, observing the static precautions described in Chapter 2. However, a reversed chip will in all likelihood have been destroyed by the application of power. All front-rear oriented chips should have their notches to the rear, and all left-right oriented chips should have their notches to the right.

Check that all internal connectors such as the floppy drive and hard disk ribbon cables and power cables are seated securely and oriented correctly. Check for broken or cracked components, particularly SIP resistor packs (thin single-row packages up to an inch long, of various colours). Check that all jumpers are seated securely, but **DO NOT MOVE ANY OF THEM**. If any jumpers are loose in the packaging or are not firmly seated, carefully check the board against the link configuration detailed in Appendix A.

The expansion connector is prone to making unreliable contact with plug-in boards if it has been contaminated by residues from skin contact or dust. Rub it very lightly on both sides with a lint-free tissue or cotton bud dampened with alcohol or methylated spirits to clean it.

Operational Faults

If your Phoenix Board runs but fails to perform correctly in some respect, you should ensure that the problem cannot be solved by inspection, as described above, before noting precise details of the fault and contacting your installer. As a general rule, try to substitute a similar Amiga (same Kickstart, memory configuration etc.) for yours to isolate the fault. Also remove all other expansion boards, background programs etc. when trying to isolate a single faulty hardware or software item. Here are some of the more common failures:

- Floppy drive(s) behaves erratically

If you shipped or transported your Amiga to your installer, it is possible that the internal drive has become misaligned, making it difficult for the drive to read your disks. If formatting and then writing and reading a new disk is unsuccessful, however, this is in all likelihood the problem.

It is also possible, though much less likely, that one of the CIA chips in your Phoenix Board was damaged during the transition to the Phoenix Board. Before condemning one or both of your CIA chips, try swapping their positions and see if this solves the problem.

- A peripheral fails to work correctly

Apart from the expansion connector, discussed above, any external connector can fail if its pins are bent or dirty. It is also possible that the chip(s) connected to a given port were damaged by static when a connection was made. NEVER CONNECT OR DISCONNECT ANYTHING FROM THE AMIGA WHEN SWITCHED ON. Check the peripheral on another Amiga if possible.

Due to design limitations of the original A1000, attaching two or more peripherals to the expansion connector may cause the Phoenix Board or your peripheral to fail or behave erratically due to the load placed on it. Although it is designed to perform better than the original A1000 in this respect we cannot guarantee this, particularly where the SideCar is used.

- Software fails to run or crashes

If you have been using an early version of Kickstart (1.1 or 1.2) some of your software may fail under 1.3, which is supplied with the Phoenix Board. This applies particularly to games. If you really must run such software, the Kickstart from disk option will be available in a future version of the RAM controller PAL. Contact Phoenix Microtechnologies if this is required.

Some software is also affected by the presence of the Obese Agnus, which differs from the old A1000 Agnus in several subtle ways, as well as supporting 1Mb of chip RAM. Run the software on a A2000 or A500 with an Obese Agnus and 1Mb of chip RAM to ascertain whether this is in fact the problem. Appendix B discusses the various possible memory configurations of the Phoenix Board more fully.

- Some Keyboard keys don't register characters on the screen

Turn the computer off and jiggle the telephone type connector on the keyboard cable. Restart the computer and retry the keys.

- Peripherals plugged into the Parallel and/or Serial ports do not function correctly

Try swapping the positions of the two CIA chips. If this does not alleviate the problem then the CIA chips could be damaged and need replacing. If using A500/A2000 devices on the parallel port a parallel port adapter will be required to re-route the power and data signals. Failure to do this will often result in damage to your computer and the device

- Sounds seem slightly different

Because the audio filter in the Phoenix Board is software-switchable, many games and audio sampling programs which turn off the filter will sound much clearer than with your old A1000, whose filter could not be disabled. The filter is disabled when the Power LED is dim.

- Phoenix Board will not boot with Kickstart 1.2 or earlier

Your SCSI hard disk will autoboot under Kickstart 1.3 (and 2.0, when available), but not 1.2 or 1.1. Under 1.2 you must boot from floppy and mount the hard disk through the startup-sequence. The hard disk drive software will not work under 1.1.

- Phoenix Board fails with A2000 card installed

As stated in Chapter 1, virtually all standard A2000 cards will operate correctly in a Phoenix Board with link L15 out, L117 all three out, L18 and L19 in with our custom PAL (70A) fitted. However, if you have a non standard board that will not work, contact Phoenix Microtechnologies for technical advice.

The second potential problem concerns not the A2000 socket itself, but boards that do not autoconfigure. If this is the problem replace link L15 and try again. If it still fails to work, contact Phoenix Microtechnologies for technical advice.

- Pins do not align with the socket holes

If the pins on your chips are splayed out and do not align with both sets of socket holes, try the following. Hold the chip firmly at both ends with a finger and thumb and place it on it's side on a flat antistatic surface. Gently roll the chip until the pins come into contact with the flat surface, and apply pressure until the pins bend inward a fraction. NEVER USE EXCESS FORCE. Check the pins alignment with the socket, and repeat if necessary.

If you still need help - If you have followed the above suggestions and still feel that your Phoenix Board has a fault, please read **Service Guidelines** at the end of this document, which explains the procedure for obtaining service from us and the conditions under which we accept liability for faults.

Chapter 4

Installing a Hard Drive

If you bought a hard disk with the Phoenix Board and had us install it, it should boot when you turn your Amiga on. If you wish to install your own SCSI hard disk, you should follow the instructions given here. To make this manual clearer, all Phoenix and AmigaDOS programs, directories and files are referred to with bold-italics, and the command lines which use them (text typed in at the CLI) are in plain italics. Please ensure that your Amiga is **OFF** before plugging or unplugging the drive connectors. Do not move the drive while it is spinning (allow 20 seconds after power is removed).

Please note: Some details in these instructions are specific to Quantum LPS Hard Drives. Where differences between drives will occur this is pointed out. These instructions are for use with Version 2.0 of the SCSI disk and Version “F” of the autoboot EPROM, or later.

How Autobooting Works

When your Amiga boots up, it looks through a list of devices which have made themselves available for booting, each of which has assigned itself a priority, and tries to boot from each in descending order of priority. The internal floppy drive has a higher priority than your hard disk, so if there's a disk there the Amiga will try to boot from it. If it's not a bootable floppy, the Amiga will try the hard disk next. If it cannot boot from your hard disk it will display the “hand” picture, asking for a bootable floppy.

Even when the Amiga boots from a floppy it still recognises your hard disk, which will be mounted and ready to use even though the startup sequence on the boot floppy makes no reference to it. If you wish the hard disk to be completely ignored (to conserve memory or avoid viral attacks on it) you must hold down the left mouse button while your Amiga boots, releasing it only when you see the boot floppy request or CLI window.

Installing a Hard Disk

See page 29 for instructions on fitting the drive into the original A1000 case.

This section shows you how to configure any SCSI hard disk for autobooting with the Phoenix Board's controller. There is an installation script on the supplied disk for people who are installing Quantum LP52S (52Mb) or LP105S (105Mb) hard drives. People who use any other drive will need to manually install their hard drive. Although you should not experience problems, we cannot be responsible for difficulties caused by faulty or incompatible drives. At the end of this section we present an example installation session; please refer to it if any of the procedure below is unclear to you.

(1) Selecting a drive

This controller requires an Embedded SCSI hard drive. This is the type most commonly found in Macintoshes and Amigas, and can be identified by the presence of a 50-pin dual-row header at the rear of the drive, with no pins missing.

SCSI drives are not specified as containing a given number of cylinders and heads, but simply a number of blocks (or sectors), each of which is 512 bytes long. If you are unsure of the size of your SCSI hard disk, the program *scsi_info* (explained later) on the supplied disk will tell you.

You should check the drive's SCSI address (or **ID**), which is determined by three DIP switches or links on the drive which together form a binary number from 0 to 7. This should be set to 0 for the drive from which you intend booting. Other drives or SCSI devices must have different IDs to avoid conflict. You cannot use an ID of 7, which is reserved for the controller. Quantum drives purchased from Phoenix Microtechnologies are set for 0 (all links at A0, A1 and A2 are removed). Do not move any other links, such as those labelled SS, EP and WS on the Quantum drives. Consult the documentation for your drive, if it was not purchased from Phoenix Microtechnologies, for the location of the SCSI ID links or switches.

(2) Connecting the Hard Disk

If you purchased your hard drive and/or mounting kit from Phoenix Microtechnologies then you will have all necessary cables. If your hard drive is to be internally mounted, connect one end of the 50 way cable to the 50 pin header on the rear of the hard drive, and the other end to the 50 pin header (JP6) on the Phoenix Board. Please make sure the insulating sleeve fitted on the bottom two pins of the JP6 is removed before the cable is fitted. Please make sure pin "1" of the hard drive is connected to pin "1" of the JP6 header (Indicated on the board by a diagonal line across one corner ). Pin "1" is indicate on the board and hard drive by a number "1" near the headers. Pin 1 of the cable is indicated by an arrow or a "1" on each of the plastic connectors, and by a coloured stripe along one edge of the ribbon itself. You may wish to show hard disk activity by mounting the tricoloured LED on the front of the case as per diagrams 2-7 & 2-8 and instructions on pages 29-30.

If the drive is external you should obtain from us a cable which will connect the 26-pin header (JP4) which is adjacent to the 50-pin header (JP6) to a 25-pin DB connector which can be mounted on the Amiga's case. This can be connected to your drive by means of a suitable 25 to 50 pin adapter, also available from us. Other external SCSI devices, such as scanners and tape drives, can also use this connection in a daisychain fashion.

Now connect the power cable to the drive and the board (connectors are polarized so that they only go on one way without force), and boot from the supplied floppy disk. There is an installation script that will install a Quantum 52Mb or 105Mb hard drive automatically. All you need do is answer a couple of simple questions and have your Workbench and Workbench Extras disk handy.

If you prefer to do it manually, boot from the supplied disk. If you'd prefer to boot from your own floppy, transfer the following files from the supplied disk into the same directories on your boot disk.

- *devs/scsi.device*
- *c/scsi_format*
- *c/scsi_info*
- *c/scsi_auto*
- *c/scsi_mount*
- *L/FastFileSystem* (if not present already)

The SCSI utilities in the c directory (*scsi_format*, *scsi_info*, *scsi_auto*, *scsi_mount*) are described fully in *SCSI_utilities.doc* on the supplied diskette; only examples of their use are shown here.

(3) Pre-formatting the Hard Disk

Quantum hard drives supplied by Phoenix Microtechnologies do not need to be pre-formatted - go to section 4 if you purchased your Quantum drive from us. Before a SCSI hard disk is used with the Amiga it should be pre-formatted, a process which completely erases the hard disk and finds blocks with errors, marking them so that they won't be used by the Amiga. This is done by typing:

```
CLI> scsi_format 0    (0 is the drive ID)
```

from a CLI to enter the hard disk pre-format program, which will print an error message if it cannot find the hard disk. `scsi_format` will ask for confirmation before pre-formatting the hard disk, since it COMPLETELY ERASES THE DRIVE. Pre-formatting a Quantum LPS drive takes only a couple of seconds, but all other drives we have seen require several minutes. However, don't assume that a pre-format has failed unless `scsi_format` indicates this.

(4) Mounting the Boot Partition

The utility `scsi_mount` is used to mount the boot partition, avoiding the need to edit a mountlist. You should run `scsi_info` to find out how many blocks the drive has before deciding how large the boot partition will be. Note that the size reported by `scsi_info` will generally be a little less than that quoted by the manufacturer, since formatting data and areas allocated for bad blocks use some space. The `scsi_mount` has the format:

```
CLI> scsi_mount name: LowCyl HighCyl Surfaces BlocksPerTrack [Unit]
```

where LowCyl, HighCyl and BlocksPerTrack are the parameters normally found in a mountlist Unit is the drive ID, and can be omitted for the boot partition and any others on drive 0. Name is the desired device name of the partition (not to be confused with the volume name, which is assigned by the format command later). DH0: is commonly used, but this can be anything you like within a 10-character limit.

The Surfaces and BlocksPerTrack parameters can be set to any value you please, but we suggest using Surfaces = 8 and BlocksPerTrack = 25, which gives 200 blocks (100K) per cylinder, making partition size calculations easy. You can then choose LowCyl and HighCyl, bearing in mind that $(HighCyl+1)*Surfaces*BlocksPerTrack$ should not exceed the size of the hard disk in blocks. See the example installation session for an example of this. For more information and examples on using LowCyl and HighCyl to create partitions (multiple virtual drives) please see "Partitioning Your Hard Drive".

When `scsi_mount` is run no hard disk activity will be seen; only when you attempt to access the drive (with a CLI command such as `cd` or `copy`, for example) will the drive be accessed and appear in the AmigaDOS info command's device list.

The hard disk must now be formatted. Unlike a floppy it is not necessary to format the entire disk, since the pre-formatting process guarantees that AmigaDOS will find no errors on the disk. However, if you have made an error in the `scsi_mount` command formatting the entire drive will alert you to this. Type the command:

```
CLI> format drive DH0: name "diskname" QUICK
```

(where "diskname" is a name you choose for the disk). The hard disk is now ready to store files. To perform a full format, which could take up to half an hour, omit the QUICK keyword.

(5) Preparing to Autoboot

At this point you should copy the contents of your boot disk to the hard drive, simply using the command:

```
CLI> copy sys: dh0: all
```

Next, check that the L directory on the hard disk contains **FastFileSystem**, since this is required to set up autobooting. Use the AmigaDOS 1.3 revision of the FastFileSystem which is on the supplied diskette (about 12K long). See COMPATIBILITY for more details. **FastFileSystem** must always be on the hard disk in the L directory.

Lastly, type:

```
CLI> scsi_auto
```

which requires no parameters here, to store the autobooting information required by the controller in the first sector of the hard disk, and reboot without a floppy in DF0:

Note that if the location of **FastFileSystem** in the **L** directory of the hard disk ever changes you must run **scsi_auto** again before attempting to autoboot. This may occur if you delete the file and replace it or use a disk organiser such as B.A.D. or QuarterBack Tools. The same is true if the hard disk is reformatted.

An Example Installation Session

Let's presume you wish to install a hard disk with 102,165 blocks (the Quantum LP52S 52Mb drive). We'll use CLI> to indicate a CLI or shell prompt, and italics to indicate information and questions printed by the SCSI utilities. Comments are enclosed in angle brackets.

```
CLI> scsi_info 0
```

```
SCSI Informer by Michael Warner  
Version 2.0 (8/91) © Phoenix MicroTechnologies
```

```
Manufacturer: QUANTUM  
Model: LP52S  
Revision: 2.8  
Size: 102165 blocks (49Mb)
```

```
CLI> scsi_format 0
```

```
SCSI pre-formatter by Michael Warner  
Version 2.0 (8/91) © 1990 Phoenix Microtechnologies
```

This program will pre-format your hard disk, erasing all data. * Not necessary for Phoenix supplied Quantum drives

```
Are you sure you wish to proceed [N] ? Y  
Pre-format drive at address 0 [N] ? Y  
Pre-formatting, please wait...done.
```

<Set up boot partition to fill entire disk>

```
CLI> scsi_mount DH0: 0 2083 1 49
```

```
CLI> format drive DH0: name "MyHardDisk" QUICK  
Insert disk to be formatted in drive DH0: and press RETURN:
```

```
Initializing disk <takes about 5 seconds>
```

```
CLI> copy sys: DH0: all <file copy messages appear>
```

```
CLI> scsi_auto  
SCSI AUtoboot configuration by Michael Warner  
Version 220 (8/91) © Phoenix MicroTechnologies
```

```
Found partition DH0 on drive 0  
Data stored - drive ready for autoboot
```

Partitioning Your Hard Drive

The Amiga can divide a hard disk into multiple smaller drives, or partitions, each of which appears as an entirely separate drive, and is bounded by its LowCyl and HighCyl parameters. The boot partition is just one of any number you can have on your hard disk. Rather than create mountlist entries for each partition, *scsi_mount* will quickly mount other partitions with the minimum possible memory penalty. The *scsi_mount* command format is the same as for the boot partition; once you have formatted a partition you can put its *scsi_mount* command in your *startup-sequence*. For example, a Quantum LP52S (drive 0) could be divided into five partitions as follows:

```
scsi_mount BOOT: 0 999 1 49  
scsi_mount P2: 1000 1499 1 49  
scsi_mount P3: 1500 1699 1 49  
scsi_mount P4: 1700 1899 1 49  
scsi_mount P5: 1900 2083 1 49
```

Please Note: An icon will not appear on the workbench screen for these partitions until you access them. We recommend you use:

```
CD P2:  
CD P3:
```

and so on in the StartUp-Sequence to have icons appear on the workbench from bootup.

Notes:

- The Surfaces and BlocksPerTrack should be the same for all partitions to avoid confusion
- These partitions will not appear on the WorkBench as icons or in the info command's device list until some other reference (eg with CD) is made to it
- The scsi_mount command does not cause the partition to be accessed. This conserves about 20K of memory until the partition is actually used.

Although they consume memory when mounted, partitions enable you to hide areas of your hard disk you wish to keep private (unless you know the LowCyl and HighCyl of a partition it cannot be accessed) and test programs which may be destructive or corrupt the disk. They can also be used for quick backup, since a "diskcopy" can be done between two partitions of the same size on the same or different drives.

Adding More Drives or Other Devices

If you wish to add more SCSI drives or other SCSI devices (e.g. a tape backup unit or scanner) you will need to mount a DB25 (25-pin D-shape) connector on your Amiga, and connect it to the 26-pin header on the controller (please refer to page 22). Please contact us for the necessary hardware to do this. External devices each have two DB25 ports so that they can be connected in daisychain fashion. Make sure their IDs do not conflict with each other or the internal drive. The terminators (usually resistor packs) on SCSI devices not at the extreme ends of the bus must also be removed.

Configuration of extra drives is the same as for the boot drive, except that the drive ID parameter for *scsi_info* and *scsi_format* will be different and the ID should be appended to the *scsi_mount* command line. There is no need to run *scsi_auto* unless you modify the boot partition.

Compatibility

A hard drive must cope with many variations in the Amiga environment, but the only factor which will affect you is the version(s) of AmigaDOS you wish to run:

- **AmigaDOS 1.2** does not support autobooting, so when the Kickstart switch is used to select it the Phoenix Board will not attempt to boot from the EPROM driver. You may use *scsi_mount* or *mountlist* entries to mount partitions; the driver (*devs:scsi.device*) and *L:FastFileSystem* will both be read from the boot floppy. You MUST use the 1.3 version of the *FastFileSystem* which is in the *L* directory on the supplied diskette (12248 bytes long), NOT the 2.0 version (currently 21596).

- **AmigaDOS 1.3** -You MUST use the 1.3 version of the *FastFileSystem*, which is 12248 bytes long, NOT the 2.0 version (currently 21596 bytes) on the supplied diskette. This is located in the *L* directory of any original 1.3 Workbench disk.

- **AmigaDOS 2.0** includes the *Fast File System* in ROM, but we decided to continue to load it from the hard disk when booting so that any newer version released by Commodore could be installed merely by copying it to the hard disk and running *scsi_auto*. The 2.0 *Fast File System* offers extra facilities which may be required by some 2.0 software.

In summary: Install the 1.3 *Fast File System* with *scsi_auto* but use the 2.0 *FastFileSystem* on hard drives when using Kickstart V2.0.

A-Max Support

The *devs* directory of the supplied diskette contains *scsi.amhd*, an A-Max driver for the Phoenix Board's SCSI controller - the *scsi.amhd* driver supplied on the A-Max diskette will NOT work with the Phoenix Board. Copy it into your *devs:* directory and follow ReadySoft's instructions for its use.

SCSI-Direct Support

The SCSI driver supports Commodore's SCSI-Direct protocol, which enables software to directly send any SCSI command to a SCSI device. This facility is used mostly by tape backup software. For more details and example code, see the **SCSI_Direct** drawer on the supplied disk.

Troubleshooting

This section covers common problems you may experience installing or using the Phoenix Board's SCSI controller.

(1) SCSI utilities can't access hard drive

This can occur for several reasons:

- No drive with the ID specified. Check that the drive's ID is set correctly, and that no other drive or SCSI device has the same ID. The boot drive must have an ID of 0.
- Drive not connected properly. Check the orientation of the data and power cables to the drive, and that they're seated securely. You should be able to hear the drive spin up when the Phoenix Board is turned on.
- Driver not available. If you booted in AmigaDOS 1.2, or AmigaDOS 1.3 with the left mouse button held down to avoid autobooting, *scsi.device* must be in the devs directory of the boot disk.
- Auto-configuration problem. Some memory boards, including early MAST Mini-Megs units, don't auto-configure correctly and thus prevent the SCSI controller from auto-configuring. Try again without any peripherals connected to the expansion port. The SideCar may also cause this problem.

(2) scsi_info returns garbage

Some drives don't return their identification and size data in the format expected by *scsi_info*. If this occurs try running *scsi_info.old* from the *c* directory of the supplied diskette. This prints out all data in one string, allowing for more flexibility in the data format.

(3) Drive won't autoboot

Assuming that you have created a boot partition and run *scsi_auto* to set up autobooting, failure to autoboot could occur for the following reasons:

- Using Kickstart 1.2 or earlier
- Kickstart swap switch not installed correctly, or link L35 incorrect
- Drive too slow to spin up on power-up. If the Phoenix Board hangs or ignores the hard drive on power-up, but autoboots when subsequently rebooted, your drive is too slow in spinning up. The Phoenix Board allows about 6 seconds for the drive to spin up; allowing any more time would make booting without a hard drive connected very slow.

(3) Partition can't be accessed after mounting

Mostly occurs for reasons in (1) above, but when running 1.2 or 1.3 with autobooting disabled can be caused by failure to have *scsi.device* and *FastFileSystem* on boot disk.

(4) Phoenix Board crashes when autobooting

Probably caused by movement of the *FastFileSystem* file or corruption of the autoboot information. Boot with the same floppy you used to first mount the boot partition (holding down the left mouse button), mount the drive and run *scsi_auto* again.

(5) Drive from another controller won't boot on Phoenix Board

The Phoenix Board's SCSI controller doesn't yet support Commodore's RDB standard, which standardizes the partitioning information to allow interchange of drives between controllers. DON'T run *scsi_auto* on such a drive, since this overwrites some of the RDB data written by the other controller. Use its setup program to determine the LowCyl, HighCyl, Surfaces and BlocksPerTrack of the partition(s) you wish to access and use *scsi_mount* to access them. Conversely, don't write RDB data to an autobooting Phoenix Board hard disk - most controllers allow you to mount partitions manually.

Jumper Settings

The Phoenix Board links relating to the SCSI Port will already be set correctly when you receive it, but just for reference these are the correct settings:

- L12, L14 in
- L33, L37 out
- L35 centre and right pins jumpered (if Kickstart Swap Switch not installed)
- L31, L32 centre and lower pins jumpered

General Notes

This section gives you some tips on managing your hard drive and understanding its behavior. You should make a note of the location of the partitions on your hard disk(s), as well as the other parameters in the mountlist, and store it in a safe place. Perhaps the best way to do this is to create a boot floppy from which you can *scsi_mount* all partitions on the drive.

The pre-formatting process should remove the possibility of read/write errors in the immediate future, but as hard disks age they may develop more errors. If you see a read/write error requester when reading or writing to the hard disk it is probably caused by a corruption of the data on the disk (a soft error) rather than a fault in the magnetic surface of the disk (a hard error). A corrupted file may often be recovered with the use of a sector editor such as "DiskX" or "Sectorama" (both on supplied diskette) or a file recovery program like DiskSalv (on supplied diskette) or QuarterBack Tools. If deleting the file or directory causing the problem does not help, you must format the partition (and run *scsi_auto*) again. You should always keep an up-to-date backup of your hard disk with a backup utility - we recommend Quarterback, which we use in-house and sell.

While hard disks are much more rugged now than in days of yore (the 80s!), they are still much more fragile than anything else in your Amiga. Treat your Amiga gently if it contains a hard drive - in particular, do not move it while the hard drive is spinning. If your Amiga is often moved, a warning sticker on the front panel may be appropriate!

Although the fast file system used by your controller is very fast and efficient, you will find access to your hard disk slow and cumbersome if you place too many files in any one directory. You should take advantage of the Amiga's hierarchical (tree-like) file structure to create several levels of directories, rather than filling the root directory (top level) with all your files. Also, once you've deleted and created a lot of files on the hard disk it will become fragmented - that is, your files will occupy a lot of small areas on the disk rather than one large area, which slows down reading and writing. Programs like B.A.D. and QuarterBack Tools can solve this problem by re-organising your files (you should back up your hard disk before using them), but remember to run *scsi_auto* again afterwards as the *FastFileSystem* will have also been moved.

Your hard disk is supposed to make your life easier, not harder. If you run into any problems you can't solve, please contact us for help with the exact details of your problem. Enjoy!

Fitting a Quantum 1" high Hard Drive - Inside Original A1000 Case

WARNING - The SCSI hard disk drive unit is extremely delicate. DEFINITELY don't drop it. Only remove it from its anti-static bag when you are ready to install it into your Amiga. Do not touch the underside of the hard disk drive (the electronics etc.) as you may damage the components with static electricity, and do not apply pressure to the top of the hard disk drive.

Please note: This metalwork should be done well away from your Amiga and your hard disk drive. Take the template (supplied) and cut along the lines (as per template). Fold along the line as shown on the template to create a right angle. Place the top section of the shielding from the A1000 upside down, with the front facing towards you. Place the side of the template marked 'front panel' towards the front panel. The hole marked on the template should line up with the hole in the shielding. The fold line should be pushed hard against the right angle bend in the shielding (at the front). The side marked 'line up with edge' should line up with the other right angle bend in the shielding. To check that the template is in the correct position, the 'top line' of the template that reads 'front panel' should line up with the section of the shielding that covers the 256K front memory expansion unit of the original Amiga 1000.

The two areas of the template that are shaded, need to be marked out with a scribe, and an 8.5mm (or larger) hole drilled in the four corners of the waste of the main hole for the hard disk drive. Now, using a nibbling tool (i.e. Tandy 64-823 approx \$20) nibble out the waste material that is shown on the template by the shaded areas. Now file the new holes lightly, to remove any sharp edges, and make sure that the longest sides of the hard disk drive hole are very flat. Now remove any swarf, or foreign metal objects from the shielding, as if these get into your Amiga, it will cause endless problems.

Secure the brackets to the hard disk drive by firstly removing the hard disk drive from its anti-static bag, and laying it upside down on top of the bag. The bracket is screwed on by four M3 screws that should be done up firmly but not over-tightened. The brackets with the self adhesive tape should protrude from about half-way up the hard disk drive. When the hard disk is installed, the components on the underside of the hard disk should face the components that are on the Phoenix Board and the front of the hard disk (the bezel) (the panel with the hard disk active light on it) should face towards the front of the computer. Using methylated spirits, clean the areas on the RF Shield where the adhesive will stick to (to give better adhesion). Plug both of the cables (power and 50 way SCSI cable) ensuring that both are orientated correctly. The 50 way SCSI cable will have to be folded, so that it is flat, but will fit in to the SCSI port on the Phoenix Board. Ensure that the hole that you have cut is large enough for the hard disk before removing the backing on the adhesive. Remove the backing on the adhesive, feed the two cables through the top of the case and gently stick the hard disk in position, so that the bezel of the hard disk is almost touching the front of the hole. This should allow clearance at the back of the hard disk for the cables.

Plug the power and SCSI cables on to the Phoenix Board, wrap the power cable from the power supply around the supporting post in the centre of the board (ie. so that the cable isn't under the hard disk drive) and re-assemble the Amiga. With the front panel off, ensure that the top half of the case does NOT touch the hard disk. The hard disk may lay on the 50 way SCSI cable, and this is OK, so long as there isn't much pressure between the hard disk drive and the Phoenix Board. When re-assembling the case, be careful not to catch any of the wires between the mounting posts and the threads on the lid.

We suggest that you install the external SCSI extension cable (AP1001-HE) at this time, especially if you intend to plug in any other SCSI devices at a later date.

Fitting the Phoenix Board Power and Hard Disk LED

The following instructions are for Phoenix Boards with a serial number of #PHNX7A

Fit the LED as follows:

1. Power unit off
2. Fit single wire to "LED 2" connector with the marked edge towards the bottom (bottom 2 pins). Refer to Diagrams 2-7 and 2-8.
3. Fit socket with double wires to "LED 1" connector with the marked edge to the top. Refer to diagrams 2-7 and 2-8.

Conditions are as follows:

Power:	LED Orange
Hard Drive Active:	LED Green
Ambiguous Condition	LED Red - Fault

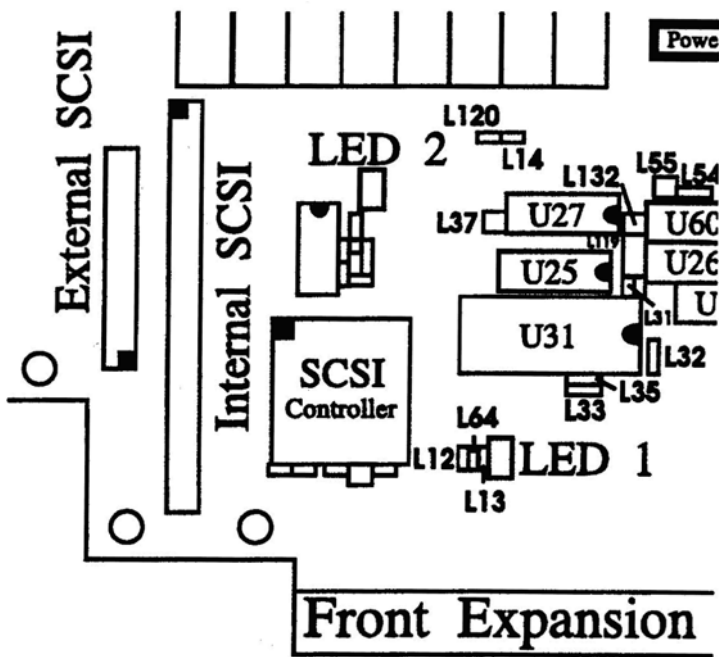

Figure 2-7

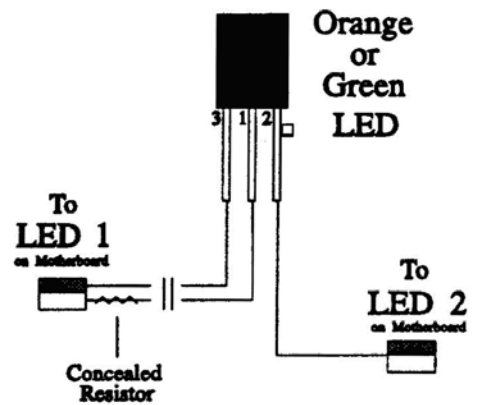
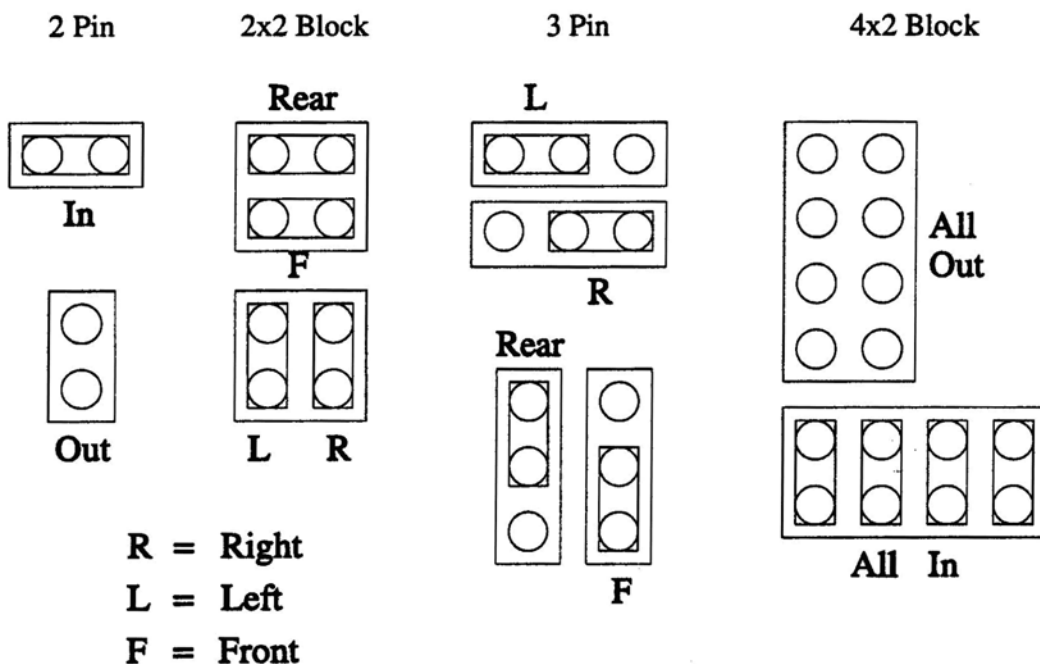

Figure 2-8

Appendix A - Link Configurations

This appendix describes the positions of the links in a standard Phoenix Board (none of the accessories installed), and goes on to detail the changes relevant to the board's various options. There are three different kinds of link on the Phoenix Board:

- The two-pin link, which is simply **in** (link present) or **out** (link not present);
- The three-pin link, which can be either **left**, **right** or **out** for a left-right oriented link, or **rear**, **front** or **out** for a front-back oriented link.
- The **link block**, which consist of two or more two-pin links side by side. For 2x2 blocks the orientation of the links is given; for larger blocks (e.g. 3x2,4x2), the links are oriented perpendicular to the block itself.



Standard Phoenix Board Links

In each list, the links are listed in rough back-to-front left-to-right order. Links not listed are out.

Two-pin links:

- links R88, L126, R42, L18, L19, L103, L2, L15, L16, L121 (under agnus), L122, LI, L43, L133, #L10, L105, L3, L106, L107, L46, L14, L28, L53, L44, L12, L64, L13, L45, in

Three-pin links:

- links L25 rear, * L125, L4, L41, L58, L35 right, LI1, L57, L56 left, L31, L32, L40 front.

Link blocks:

- links JP8 all four in, L55, L132 right

* L125 is a special case. It is the feed for the internal "jiffy" time and date clock. If set to the left it is fed from the 50hz main "tick" from the PSU. Set to the right it is fed from the 50hz vertical sync. The former is more accurate but the latter allows the use of IBM type PSU's or batteries.

- #L10 - ForNTSC - in (28,636Mhz)
- For PAL - out (28.37516 Mhz)

Accessories - Link and Chip Changes

Each Phoenix Board accessory which affects the chips or links on the board is listed here, along with those changes:

8Mb Daughterboard

- If 8Mb daughterboard is in position
- link L16 out

These link specifications are subject to change as aspects of the Phoenix Board are altered or upgraded.

Appendix B - Memory Options

This appendix describes the various possible memory configurations of the Phoenix Board, but much of this discussion also applies to all other Amigas. Although a technically daunting area for some, some software available for the Amiga will run with difficulty (or not at all) under some of these conditions.

Background

The Amiga's operating system ("OS") divides installed memory into two types, which are used differently:

- **CHIP** memory is so called because it can be directly accessed by the Amiga's custom chips (Agnus, Denise and Paula) as well as the CPU. Because the OS relies on these chips to manipulate graphics and sound on the Amiga, this is the only type of memory which can hold graphical data to be displayed and audio data to be heard. The Amiga must have chip RAM to function, since even the initial Workbench screen is allocated from chip RAM.
- **FAST** memory is only accessible to the processor, and therefore cannot be used to display graphics and play sound. It is used to hold the ramdisk, program code and to store graphic and audio data.

Because most Amiga programs make extensive use of graphics and/or audio, chip RAM is a precious resource. If the OS wishes to load program code or data suited to fast RAM and none is present, it will use chip RAM instead. It is therefore advisable to maintain a reasonable proportion of fast to chip RAM to obtain the best performance from the Amiga: twice as much fast as chip RAM is typical.

The Story of Agnus

The Amiga's chip RAM is addressed (or controlled) by the Agnus chip, which in many ways is the heart of the Amiga. The maximum amount of chip RAM supported by Agnus has increased over the years, in this way:

- 1985: A1000 released - Agnus (48 pin DIP) supports 512Kb chip RAM
- 1987: A500 released - Fat Agnus (84 pin PLCC) supports 512Kb chip RAM
- 1989: Obese Agnus (84 pin PLCC) for A500/A2000 released - supports 1Mb chip RAM
- 1991: Super Obese Agnus (84 pin PLCC) released (initially only in A3000) - supports 2Mb chip RAM

With each Agnus revision (except Fat Agnus) possible chip RAM has doubled, improving the Amiga's graphics and sound potential and making multitasking more effective. The Phoenix Board uses the Obese Agnus, and will accept the Super Obese Agnus when it becomes available.

The Phoenix Board

The Phoenix Board comes with the Obese Agnus and 2Mb of memory standard, which is normally configured as 1Mb of chip RAM and 1 Mb of fast RAM. However, changing links will produce different configurations. The second megabyte of RAM is normally fast RAM, but once again this configuration can be changed with links. The currently supported configurations are these:

	Installed	chip RAM	fast RAM	L55	L56	L4
@	1Mb	1Mb	OK	right	out	right
	1Mb	512Kb	512Kb	out	right	left
	1Mb	512Kb	OK	out	out	left
	2Mb	2Mb*	OK	left	left	right
@	2Mb	1Mb	1Mb	right	left	right
	2Mb	1Mb	OK	both	left	right

@ Most common configurations

* Gives 2Mb of contiguous RAM. from address 0 . Although the OS configures it all as chip RAM, the Amiga will crash when the Obese Agnus attempts to address the second megabyte; the Super Obese Agnus should address this memory correctly. This memory configuration is currently desirable for use with the A-Max™ Macintosh Emulator.

With 2Mb installed up to eight configurations are possible, some of which will be supported in the near future. If you have any specific requirements please let us know.

How this affects you

Although this configuration flexibility might seem unnecessary, it allows us to support the Super Obese Agnus and provide for software which does not run with certain configurations. The most common cases are:

- Won't run with fast memory

Some software assumes that all system memory is "chip" type, and therefore doesn't specifically request chip memory when allocating memory for itself. The effects range from graphics appearing as rubbish on-screen to complete crashes. Much software written on early 512K 1000s has this problem. Fix: use one of the OK fast RAM modes.

- Won't run with more than 512K chip RAM

The causes of this are more subtle, and often have to do with differences between the Fat and Obese Agnuses other than chip RAM support. Switching to a 512K chip RAM mode may not cure your problem - you may need to install a Fat Agnus in the Phoenix Board, which of course prevents you from using more than 512K chip RAM.

Appendix C - Model Variations

This appendix describes variations between production batches of A1000s and related peripherals which may affect the installation process or operation of the machine. The differences between PAL and NTSC A1000s are covered in Chapter 2 and hence not here.

- Soldered Connections (Installation)

Some late-model PAL A1000s have the internal floppy drive's 34-way ribbon and 4-way power connectors and the power LED soldered directly into the board rather than connected via IDC connectors. Since these cables are required by the Phoenix Board, we suggest two solutions:

- The more technically expert could remove and trim back the cables and fasten the appropriate connectors to each cable; but it is not advised.

- We sell a kit (AP1001-PC) consisting of these three cables, making it unnecessary to remove these cables from the old motherboard. Please contact us for price and delivery.

- Extra-Half-Brite Video Mode (Operation)

Early NTSC A1000s have a Denise chip which does not support the Extra-Half-Brite video mode. This six-bitplane mode produces 64 colours, the upper 32 of which are merely half-brightness versions of the lower 32. Denise chips which do not support this mode are labelled "r5" or earlier. We suggest that you buy the Super Denise (see Chapter 1) rather than purchase a late-revision current Denise chip at this time.

The program **halfbrite** on Fish Disk #1 will display a half-brite pattern; Deluxe Paint III[™] also supports halfbrite mode.

- The SideCar PC Emulator (operation)

The SideCar is a complete PC which communicates with the Amiga via a block of shared memory. It will fail or run erratically if the Amiga's bus timing is even marginally worse than spec. Also, inserting other devices (e.g. a memory board) between it and the A1000 is often not possible.

Late model SideCars are distinguished from earlier ones by the presence of several SIP resistor packs, which can be seen edge-on if you look at the underside of the board through the edge connector socket.

- Internal Floppy Drive is an "NEC" or "Matsumi" brand.

The motors on these drives come into contact with Kickstart chips on the board and this pressure stops the drive motor from spinning. These drives need to be replaced with lower profile drives to prevent damage. If these drives remain in the original A1000 with a Phoenix Board fitted, then it is not possible to fit the case back together. Using these drives in a larger case will still cause damage unless raised above the chips underneath. Warranty is void if these drives are used in original case. These replacement drives are now available from us.

Appendix D

Kickstart ROMs and Swap Switches

This appendix describes the various ways in which the four “ROM positions” available on the Phoenix Board may be used to make four or more different Kickstart (operating system) revisions available, and the use of the Kickstart Swap Switch (KSSW) to switch between them. The ROM locations are shown in Figure 2-4.

The Phoenix Board has been designed to accept a wide range of ROM and EPROM devices, some of which have greater capacity than is needed by Kickstart 1.3, the current revision of the operating system. We will therefore deal with ROMs and EPROMs appropriate for 1.3 and earlier revisions before exploring other possibilities.

The important distinction between ROMs and EPROMs, for the purpose of this discussion, is that Kickstart ROMs are created by Commodore and thus contain standard Kickstart revisions, whereas EPROMs are created by us (or possibly yourself, if you have access to an EPROM programmer) and can therefore contain any possible Kickstart, either standard or modified (e.g. Guardian virus killer installed).

Common Options

The Phoenix Board comes standard with a Kickstart 1.3 ROM supplied to us by Commodore, located in ROM position 1 (ROM#1 - U53 on the board). The majority of software runs without problems with this Kickstart, but some requires an earlier revision, either 1.2 or even 1.1 (Revision 1.0 had very limited release and can be ignored). Kickstart 1.2 ROMs are also manufactured by Commodore and sold by us, and should be located in ROM position 2 (ROM#2-U54) if used. A Version 2.0 ROM can also be used here.

The third option of interest to many users is the use of four EPROMs in ROM#3 (U55-U58), which together contain a complete Kickstart. We can copy any disk-loaded Kickstart you give us, standard or modified, into these EPROMs for use on the Phoenix Board. Please contact us for price and turnaround time.

ROM#4 is intended for a 2 megabit EPROM, which is a very expensive device at this time and not of interest to most users. It is, however, included in **Device Support Details**.

Your SCSI hard disk will autoboot under Kickstart 1.3 and 2.0, but not 1.2 or 1.1. Under 1.2 you must boot from floppy and mount the hard disk through the startup-sequence. The hard disk drive software will not work under 1.1.

The Kickstart Swap Switch

The Kickstart Swap Switch supplied is a two-position switch which allows you to switch between most combinations of two ROM positions from the four available. The three wired socket in the middle of the lead is connected with the polarizing mark to the left, (see figure D-1 and D-4) to link L42 (see figure D-2), located immediately to the left of U59. The single wired lead is connected to L35 right (see figure 2.4, page 12), with the polarizing mark to the left (see figure D-4). If there is a link already on L35, this must be removed first. The supplied link may be required across the other two pins of L42. The possible configurations are shown in Figure D-1. See Chapter 2, page 15, "Case Preparation" for locations for switches.

Switching between Kickstarts

Because the Amiga is continuously running Kickstart code (except while running some games which take over the machine completely), changing Kickstarts at any time WILL LOCK UP OR CRASH THE AMIGA. Switching back will have no effect. Rebooting (ctrl-A-A) will usually cause the Phoenix Board to run the newly selected Kickstart correctly, but if it crashes while booting you should turn off the power for several seconds and switch it back on. Switching between Kickstarts is only problem-free when done while the power is off.

If you are switching between two ROMs both capable of autobooting off the SCSI hard drive, then Link L35 is right and the single wire lead from the switch itself is left off.

Example if your using V1.3- ROM in ROM#1 and V2.0 ROM in ROM#2
 or
 V1.3 ROM in ROM#1 and V1.3 Guardian ROM in ROM#3

then the second ROM will not function correctly with the SCSI if link L35 is not left in place (right), and the single wired lead is not left off.

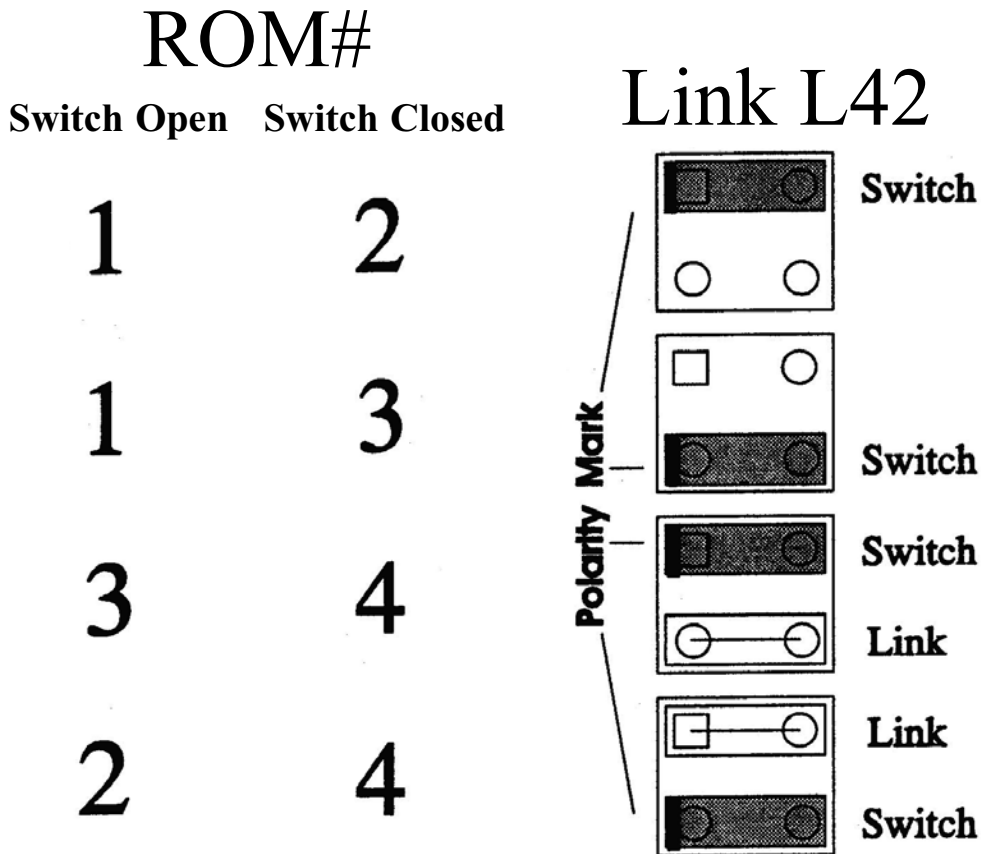

Figure D-1
KSSW Configurations

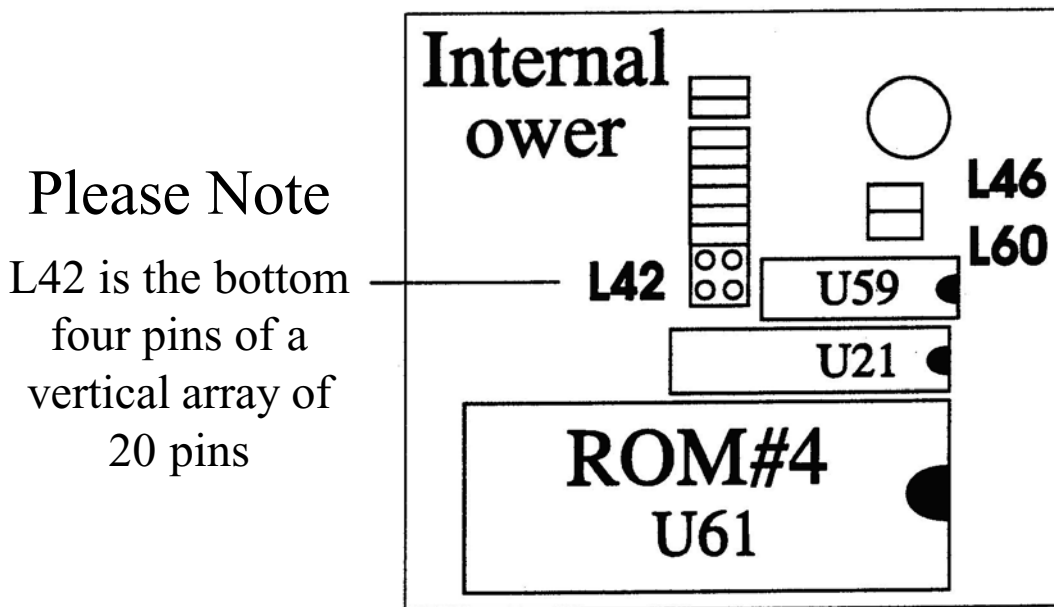
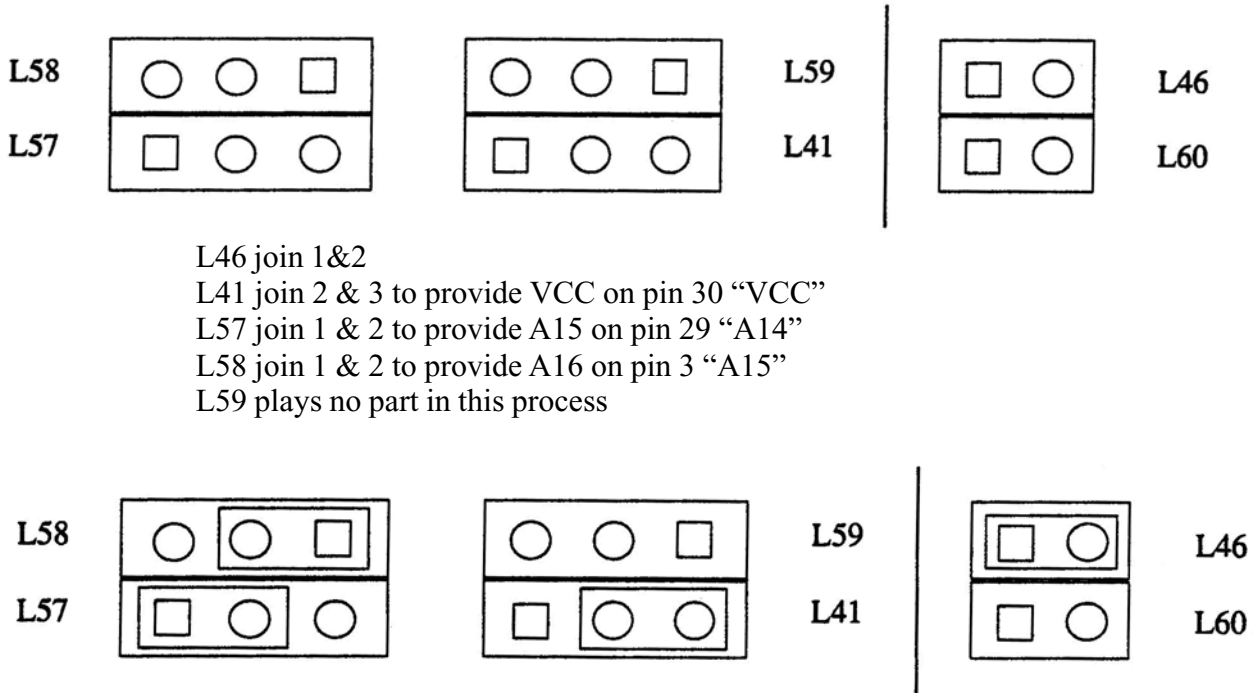

Figure D-2
Link 42 Location

Links and locations for using 27512/27C512 EPROMs in locations U55, U56, U57 and U58

Relevant Links: L41, L57, L58, L59 and L46 - These link locations are indicated on figure 2.4

□ = Pin 1



U55 is upper 8 bits of Data Bus and 1st ROM
Even 1st or U5N on A1000 NTSC or U5N on A1000 PAL

U56 is upper 8 bits of Data Bus and 2nd ROM
Even 2nd or U2N on A1000 NTSC or U5R on A1000 PAL

U57 is lower 8 bits of Data Bus and 1st ROM
Odd 1st or U5P on A1000 NTSC or U5S on A1000 PAL

U58 is lower 8 bits of Data Bus and 2nd ROM
Odd 2nd or U2P on A1000 NTSC or U5T on A1000 PAL

Figure D-3
Links for ROM#3

Device Support Details

This section describes the devices which are supported by the Phoenix Board's four ROM positions and the link changes and/or modifications required to use them.

ROM#1 (U53) and ROM#2 (U54):

A 40-pin ROM of 256Kb (V1.3 and earlier) or 512Kb (V2.0 and later) supplied by Commodore. Currently available parts are 315093-01 (Kickstart 1.2), 315093-02 (Kickstart 1.3) and Kickstart 2.0. No link changes or modifications will be required to use it. These sockets must NOT be used with 40-pin EPROMS, for which ROM#4 is provided.

ROM#3 (U55-U58):

Four 32-pin ROM/EPROM sockets which are a superset (enhanced version) of the four 28-pin sockets on the original A1000 motherboard. (See figure D-3)

They will accept the 8-bit 27C512 EPROM used in our A1000 Kickstart-in-ROM kits as well as larger 8-bit EPROMs up to the 27C080 (an 8 megabit device, sixteen times larger than the A1000 EPROMS. It is also possible with some board mods to fit battery backed static RAMS to these sockets. Because these are 8-bit EPROMs, they must be used in pairs to emulate a 16-bit Kickstart ROM.

This is a complete list of the devices which may be used:

Part No.	Size	# of pins	Availability	Cost
27C512	512Kbit	28	now	economic
27C010	1 Megabit	32	now	economic
27C020	2 Megabit	32	now	economic
27C040	4 Megabit	32	soon	expensive
27C080	8 Megabit	32	18 months	???

Equivalent non-CMOS parts may also be used e.g. 27512, 256k bit and 1 Megabit SRAMS may also be fitted.

ROM#4 (U61):

A 40-pin EPROM socket able to accept 16-bit EPROMS from 128Kbyte up to 1Mbyte; intended for custom Kickstarts.

This socket must NOT be used with a 40-pin ROM, for which ROM#1 and ROM#2 are provided.

This is a complete list of the devices which may be used:

<u>Part No.</u>	<u>Size</u>	<u># of pins</u>	<u>Availability</u>	<u>Cost</u>
27C210	1 Megabit	40	now	economic
27C220	2 Megabit	40	now	economic
27C240	4 Megabit	40	soon	expensive
27C280	8 Megabit	40	18 months	???

Equivalent non-CMOS parts may be used.

Figure D-4
Kickstart Swap Switch

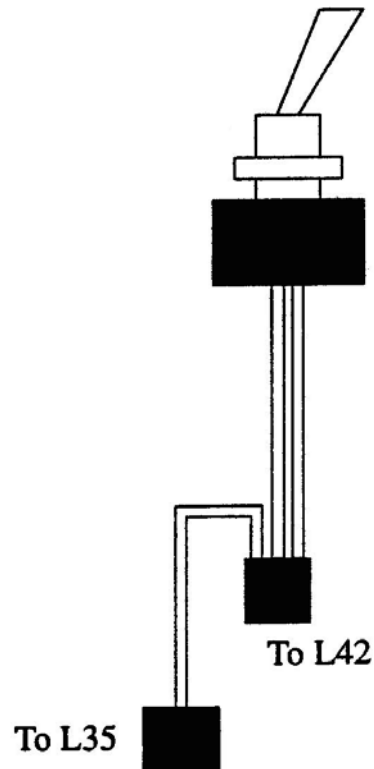

Appendix E

Phoenix Drive Swap Switch

If you are swapping drives other than DF0:, disregard the rest of this paragraph. As there is no drive identification circuitry on the internal drive, if the Amiga is powered up or reset with the switch in the changeover position, it is unable to identify the internal drive as DF1:, DF2: or DF3:. In a two drive system this effectively creates a single drive system without having to physically switch off the internal drive. To use both drives, power on or reset (Control-Amiga-Amiga) with the switch in the normal position and then switch it over when the Hand-and-Disk requester appears on the screen.

The switch can be changed over at any time although preferably not with disks in the drives as this will confuse your Amiga and may result in read/write errors and/or corrupted disks.

Installation

These instructions are written for someone with reasonable experience with electronic equipment. If you are a novice we recommend that you get a technically qualified person to install this switch. We do not accept any responsibility for your (mis)application of these instructions.

If your A1000 is already open with the R.F. shield removed, disregard the next paragraph.

Please refer to chapter two regarding opening and closing your A1000 and necessary precautions.

The drive swap switch is fitted to connector JP8 (See figure 2-4), an eight pin connector which is located next to the left hand end of the 34 way connector for the internal disk drive.

To Drives

Int Drive 1st Ext 2nd Ext 3rd Ext

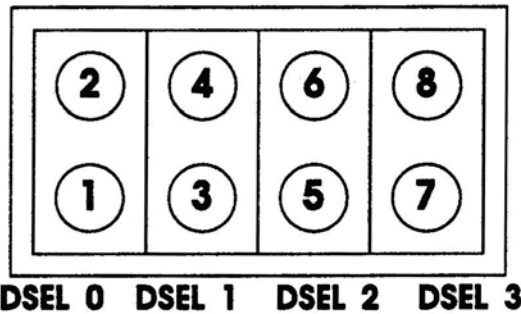

From CIA

Figure E-1
Link Block JP8

It will be seen that if the four standard link blocks are installed on the JP8 the drives will be configured as for a standard machine. By removing the 2 links from the positions of the drives that you wish to swap and installing the two 2 pin connectors from the drive swap switch in their positions, those two drives will be the ones swapped by the switch. The painted polarizing marks on the 2 pin connectors should both face toward the back of the A1000.

Drill a 1/4" (6.5mm) hole to mount the switch. Above the keyboard connector on the back panel, or inside the empty 256K RAM expansion cover are two convenient locations. Other locations may be used but pay attention to drives, R.F. shields etc. which may interfere. Please refer to chapter 2, page 15, "Case Preparation" for locations for switches.

Reverse the order of disassembly. Do not leave out the R.F. shield as this will not improve the cooling of the machine and may cause interference to TV, Radio and Amateur Radio Equipment. This is also known to cause various types of interference to DigiView.

Appendix F

Maths Co-Processor

If you intend to install the Maths Co-Processor yourself at a later date please follow these instructions.

Please make sure that the installation of any components is performed observing the appropriate anti-static precautions as detailed on page 7. The computer must be switched off to perform any installations.

The Maths Co-Processor chip itself should have an orientation mark on one of its comers. This must be aligned with the orientation mark designated on the Phoenix Board. Check that the pins on the chip are straight prior to placement in the U20 socket. Initially place the chip in the socket ensuring that all the pins align correctly with the socket holes. The chip should then be gently and evenly lowered on all sides into position so that it mounts flush with the socket.

The oscillator will have an orientation mark on the component to signify pin 1 (usually a dot or a non-rounded corner on the oscillator case). Once pin 1 has been identified on the oscillator, it should be aligned with pin 1 (usually marked with gold on the socket marked "Osc2"). The oscillator must sit flush within the socket so that it does not interfere with the bottom of the internal floppy drive (This may require cutting the pins to suit). Any oscillators supplied by Phoenix Microtechnologies have had their pins modified to suit this purpose and have been retested prior to installation.

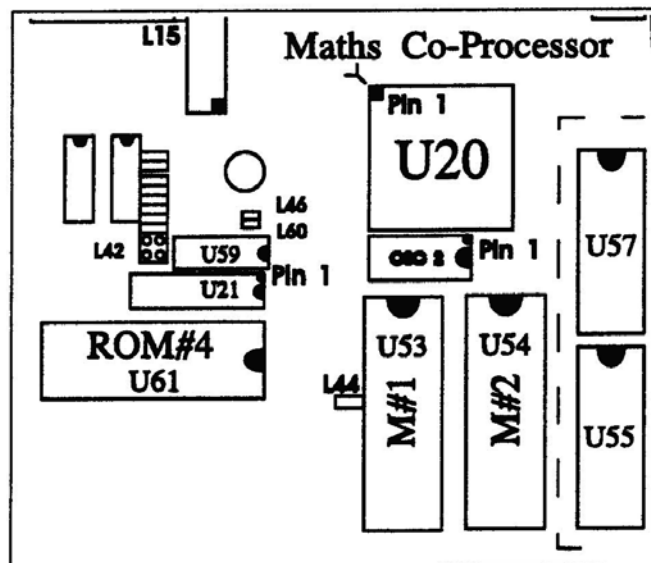

Figure F-1
Maths Co-Processor Socket

Glossary of Terms

Boot - Restart a computer system, either by turning on the power (cold boot) or resetting it on the Amiga keyboard (ctrl-A-A on the Amiga) (warm boot).

CIA - Complex Interface Adapter. A chip designed by Commodore which provides various useful functions, including two 8-bit parallel ports, serial ports and accurate timers.

Config - refers to auto-configuration, the process by which the Amiga places its peripherals in its memory map at boot time to avoid conflicts between them. The “config” signal is passed by each peripheral to the next in a controlled fashion so that each is programmed to appear at the correct memory location in turn.

CPU - Central Processing Unit (A 68000 on the A1000). The “brain” of a computer, which actually executes the programs run on the computer.

DIP - Dual Inline Package.

EPROM - Erasable Programmable Read-Only Memory. A memory chip whose contents can be erased and re-programmed by prolonged exposure to ultra-violet light.

Expansion Connector - The 86 way card edge connector on the right side of the A1000.

IEEE Maths Libraries - Institute of Electrical and Electronic Engineers, who are responsible for establishing standards. A standard format for floating-point (non-integer) numbers allowing a very wide range of magnitude and precision. Commodore’s disk-based maths libraries beginning with “ieee” use this format, as do the 68881 and 68882 maths co-processor chips.

IDC - Insulation Displacement Connector. A plastic connector designed to clamp onto the end of a ribbon cable. Sharp metal prongs cut through the insulation of each wire and make contact with the conductor within.

Interrupt - a signal used by a peripheral device (such as a 2000 card) to signal to the computer that it requires attention.

Kickstart - Is the Amiga’s Operating System including such things as multitasking and windows etc. Often used to refer to a ROM which contains the Operating System. Usually interchangeable with AmigaDOS.

Link - a group of two or more adjacent pins, designed to have a small plastic-coated metal clip connected across them.

NTSC - This strictly refers to the method by which colour video images are encoded for transmission and storage in the USA and many other parts of the world, but when applied to a particular Amiga indicates that the video signals it produces use a 60 frames/second 200 line/frame format. Conversely, a PAL Amiga uses a 60 frame/second 256 line/frame format. This is controlled by a single crystal oscillator on the Phoenix Board and L10 in.

OS - Operating System.

PAL - This strictly refers to the method by which colour video images are encoded for transmission and storage in Australia and Europe, but when applied to a particular Amiga indicates that the video signals it produces use a 50 frames/second 256 line/frame format. Conversely, an NTSC Amiga uses a 60 frame/second 200 line/frame format - see NTSC. L10 is out

PSU - Power supply unit.

PLCC - Plastic leaded chip carrier.

RAM - Random-Access Memory. Memory which can be altered and read back as often as required. The bulk of the Amiga's memory is of this type. Most references to "memory" mean RAM.

Real-Time Clock - a chip which keeps time & date internally in the same fashion as a watch. The Amiga's is powered by a small battery which maintains its operation while the machine is turned off. You need only set the date of the battery backed clock once. To set the date of the battery backed clock you must have the commands "**SetClock**" and "**Date**" in the "C" directory, and then type in at the CLI:

1. "DATE DD-MMM-YY HH:MM:SS" and hit return (eg. "date 07-MAR-91 13:41:52)
2. "SETCLOCK SAVE" and hit return

From then on you will need the line

"SETCLOCK LOAD"

in your startup-sequence.

RF Shield - a metal plate or shroud used to prevent high-frequency electromagnetic radiation from leaving a board and causing interference with other electronic equipment, particularly televisions and radios, but also Digiview and Genlocks.

ROM - Read-Only Memory. A memory chip whose contents can be read but not altered. The Amiga's Kickstart ROM is an example.

SCSI - Small Computer Systems Interface, a fast asynchronous (handshaking) protocol for the transfer of data over short distances. The SCSI standard allows multiple devices to be connected to the bus. Hard disks which communicate using the SCSI protocol are becoming increasingly popular.

SIP - Single Inline Package.

Service Guidelines

Thank you for buying a Phoenix MicroTechnologies product. In the event that your product should require service, we want you to be aware of some conditions and procedural requirements. Please read this document in its entirety before contacting us regarding a product fault or returning a product which you believe to be faulty.

Firstly, make sure you've read all of the documentation that came with the product. This will often clear up misunderstandings and assumptions you may have made. Once you are certain that the product is not performing as it should, please go through the following checklist before returning merchandise to us for repair or replacement.

1. Verify that the product is truly defective or by methodically testing it. Remove all other peripherals (hardware) or running programs (software) to produce a repeatable test environment. Apart from ensuring that the fault is not caused by something else, this will help us to re-create the fault you are experiencing.
2. Check all socketed chips. Make sure that they are fully seated and that none of their pins are bent. If you have installed chips yourself, also check that they are plugged in the right way around by comparing the notch in the chip to the similar notch in the socket. If not, replace them with new chips, since the application of power has probably destroyed them.
3. Make sure any and all jumpers are properly set; check this against the product's documentation.
4. If the product uses memory make certain the RAM chips are from a reputable supplier and that they are 120ns or faster (part number suffix -12, -10 or -80.) The use of second-hand de-soldered RAM voids your warranty.
5. Make certain that any daughterboards are properly seated on their header pins and that no header pins have been bent or missed. Make sure cards are properly seated in their bus slots. Check that all cables are firmly connected and correctly oriented (for ribbon cables, pin 1 of a connector is usually attached to the coloured wire)
6. If any case screws have been replaced make sure that they are of the correct type and are not so long as to short out any internal wiring or boards. Make sure boards are not fouling or touching each other
7. If the product contains memory, try to test it with MemoryTest (on the supplied disk, including docs.) This may not be possible for some products.
8. Check that edge connectors are clean by wiping them gently with a lint-free tissue or cotton bud dampened with alcohol or methylated spirits.
9. If the product connects to the A1000's expansion bus, remove any other peripherals from this bus. Some A 1000s do not run reliably with more than one device on the bus. If this appears to be the problem, we may be able to modify your 1000 to rectify it - please contact

10. If you experience problems when trying to run certain software with a product which contains memory, bear in mind that some software (particularly games) will not run with certain memory configurations. Please contact us for further assistance.
11. If possible, test the product on another similarly-configured Amiga running the same version of Kickstart. Try to duplicate the same fault on the other machine.
12. If the item is still under warranty we should have the warranty card you returned on file. If there was no card with the product, a dated purchase receipt will suffice. Your warranty period begins at the time of purchase, not use - if you leave a product guaranteed for one year in its packaging for a year, the warranty will expire.
13. **VOIDED WARRANTIES:** Anything which would void the warranty of your Amiga also voids the warranty of our products. This includes the removal and/or replacement of components not intended for user installation, such as the Amiga's CPU and custom chips. Any other electronic or physical abuse of a product (as determined by our repair staff) will also void your warranty.
14. Please contact us to obtain a Return Authorization Number (RAN) and make certain that this number appears on the outside of the container in which you return the product. You should use the original packaging if possible. Enclose an explanation of the problem, giving as much relevant detail as possible. A returned product without an RAN number will be treated as an out-of-warranty repair. Also include your name, address and a convenient contact phone and/or fax number.
15. All customers must pay shipping charges in both directions. **All** returns, including those normally covered by warranty, are subject to a \$50 inspection fee if found to be in complete working order, or if found to have been damaged by the customer.

If you have any questions or problems regarding these conditions or the Phoenix Board, please run through Chapter 3 and this section before contacting us. If your problem persists, or your question is not answered in this manual please write to or fax us on +618-293-8814 or call after 4 pm Australian Central Time, Monday to Friday on +618-2938752 (overseas) or 08-293-8752 (within Australia). For the fastest service indicate clearly that you have a technical problem or question and have as many details as possible to hand. Ask to speak to Customer Support Staff concerned with that area of the Phoenix Board.

We try to perform repairs (particularly warranty repairs) as quickly as possible, but we ask that you allow up to four weeks for a repaired product to be returned to you.

Amiga Hardware Database

Everything about Amiga hardware...

~

<http://amiga.resource.cx>